

Device Technologies, Inc.

Protecting Critical Equipment

2010 Product Catalog

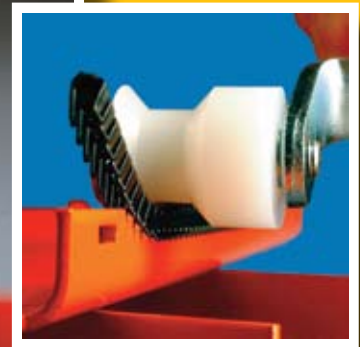
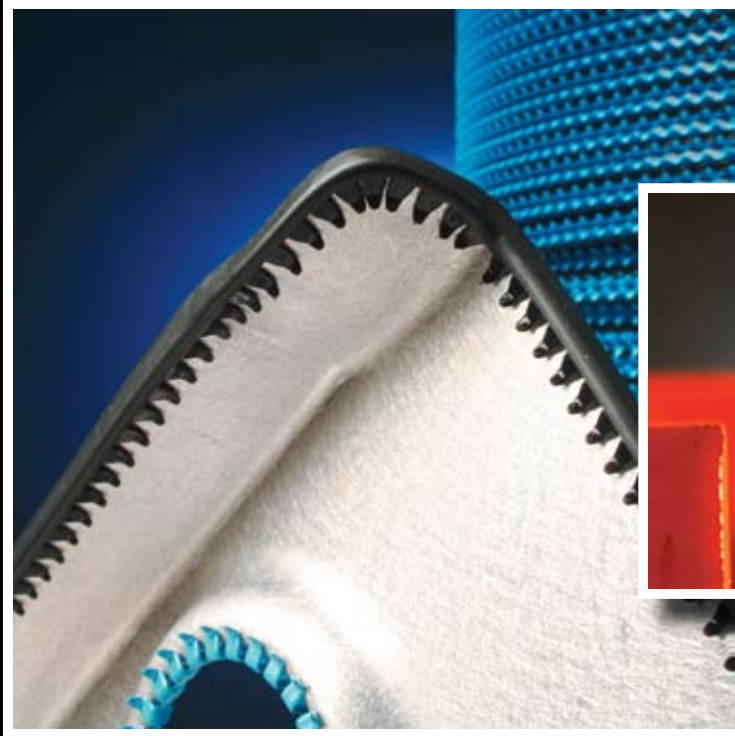

DT device
technologies, inc.

www.devicetech.com

Device Technologies, Inc.

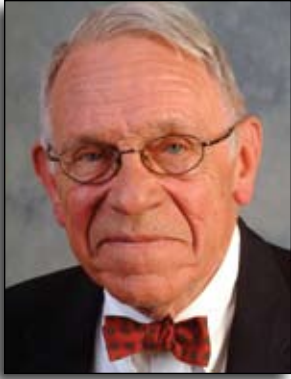

Hector D. Petri - Founder

We honor and dedicate this new catalog to our Founder and Technical Director, Hector D. Petri, who had the vision and ingenuity to piece together unrelated technical disciplines to design and develop the unique Spring-Fast® Wire Protection Grommet Edging. Now celebrating its 25th Anniversary, Device Technologies, Inc., located in Southborough, Massachusetts, commenced production from a New England farmhouse basement in 1984, expanded to the barn a few years later, and is now in a Class-A, climate-controlled facility.

Our first solution was providing Digital Equipment Corporation (now HP) with a UL94 V-0 Spring-Fast Wire Protection Grommet Edging solution to cover sharp panel edges and protect wires and cables from abrasion for their premier VAX Mainframe computer. Other key innovations were installed-cost savings and the elimination of toxic adhesives... a precursor to today's essential green movement, and RoHS compliance!

From this humble beginning, the high-performance Spring-Fast® grommet product line has steadily improved, diversified and qualified for applications in dynamic and often hostile environments such as high-and-low temperature, high dielectric strength, salt spray, chemical immersion, shock, vibration, and abrasion.

Dedication and consistent conformance to customer needs has contributed to the growth of Device Technologies, Inc. It enhances our preferred vendor status to customers throughout the world, encompassing a broad segment of industries such as Aerospace, Computer Servers & Storage, Defense, Food Processing, Information Technology, Medical Equipment, Power Systems, Telecommunications and Transportation.

As our wire protection solutions became more and more effective, even greater demands were created to further develop new and additional materials. The result of Device Technologies' ingenuity is captured within the pages of this catalog. Our team of innovative engineers and critical partners have pioneered and grown the critical equipment protection solutions to a new level leading the industry with our enclosure seals, thermal management, EMI shielding, braided sleeving and more.

Device Technologies has been designing and manufacturing innovative solutions for the OEM industry and electromechanical product manufacturers since 1984, with design expertise that embodies more than 65 years of specialty fastener vision, experience and perspective.

We continue our Founder's legacy of proven problem solving techniques that help us think outside the box to renovate current products and innovate new products. Ours is a custom approach. We stay focused on your overall operating efficiency and your business model—not simply on the individual process problem in question. Product quality and speed of assembly, combined with long term durability, reliability and collaborative support, are embedded in our design solutions that protect your competitive edge.

The Result is product after product working systematically to cut effort, time, and expense from your manufacturing. Please visit our web site for new products and all the latest news about Device Technologies at

www.devicetech.com

- DTi Quality Statement 4**
- DTi Products 5**
- Wire Protection Grommet Edging and Trim**
 - Spring-Fast® Grommet Edging.....6
 - NASM 22529 Composite Grommet Edging8
 - SL AERO Series Grommet Edging/Trim10
 - Trim-Fast™ Edge Protection/Trim.....12
 - Spring-Fast Grommet Edging and Trim Tools14
- High Performance Enclosures and Door Seals**
 - Seal-Fast™ Edge Seals.....16
 - Seal-Fast Plate-Seal18
 - Seal-Fast Tools20
- Cable Management**
 - Push-Mount™ Cable Tie System22
 - Pull-Mount Cable Tie23
 - Color Cable Ties24
 - Low Profile Cable Ties24
 - Stainless Steel Cable Ties26
 - Tefzel Cable Ties.....26
 - Fast-Drop™ Fiber Bend Radius Control Modules.....28
 - Protect-Fast™ AERO and TELCOM Braided Sleeving.....30
 - Protect-Fast Industrial Braided Expander and Shield Expander32
 - Hook and Loop Strap33
 - Cable Tie Tools34
- EMI/RFI Shielding and Thermal Management**
 - Ground-Fast™ Heel & Toe Grounding Clip.....36
 - Ground-Fast Universal and Continuous Grounding Panel Fastener37
 - FS Series Conductive Cushion Gasket40
 - FA Series RF Absorber Materials42
 - DTIM Series Thermal Interface Materials44
 - ST & DT Series Conductive Fabric Tapes46
 - SMT&DMT Series Metal Foil Adhesive Tapes48
 - S Series Stamped Finger Gaskets50
- Conversion Chart 51**
- Application Reply Forms 52**
- Services. 55**

The information contained in this catalog is based on our experience to date and is believed to be reliable. It is intended as a guide for use by persons having technical skill at their discretion and risk. We do not guarantee favorable results or assume any liability in connection with its use. Dimensions contained herein are for reference purposes only. For specific dimensional requirements, consult the factory. This publication is not to be taken as license to operate under, or a recommendation to infringe upon any existing patents. This supersedes and voids all previous literature, etc. Device Technologies, Inc. expressly disclaims any and all express or implied warranties concerning its products including without limitation, warranty of fitness for a particular purpose and warranty of merchantability.

DTi Quality Statement

Device Technologies, Inc. considers quality to be consistent conformance to customer requirements.

- To meet or exceed our customers' requirements for the quality of the products and services we provide.
- To improve the effectiveness of our Quality Management System processes and advance our use of technology continuously so as to enable our customers to become more efficient and profitable.
- To provide our employees with all necessary information, training, tools and support so that they can achieve our quality objectives.
- To treat all customers, employees, suppliers and our community with honesty and integrity.
- To conform to the requirements of ISO 9001:2000 and AS 9100 B quality standards.

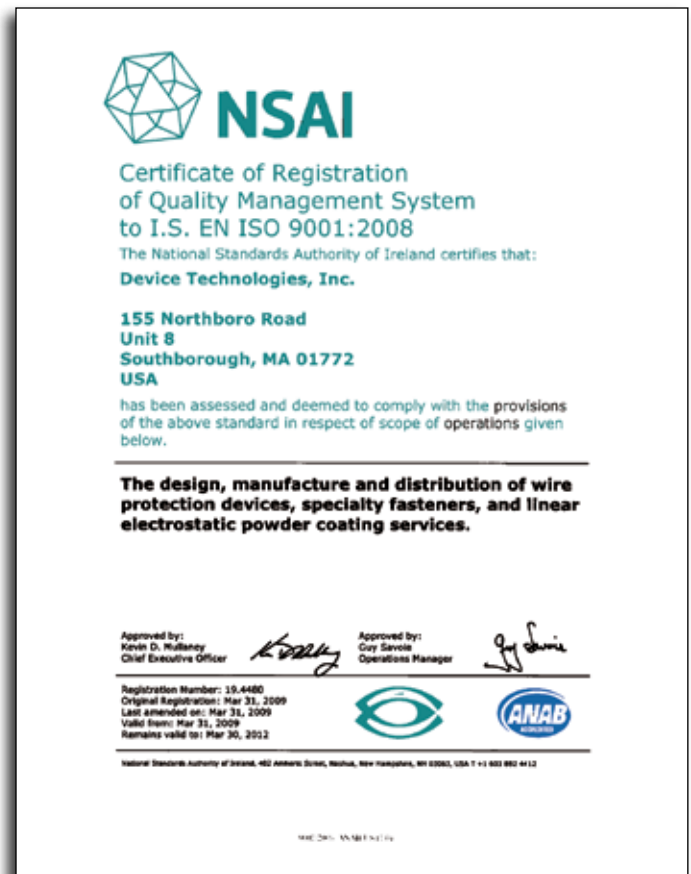
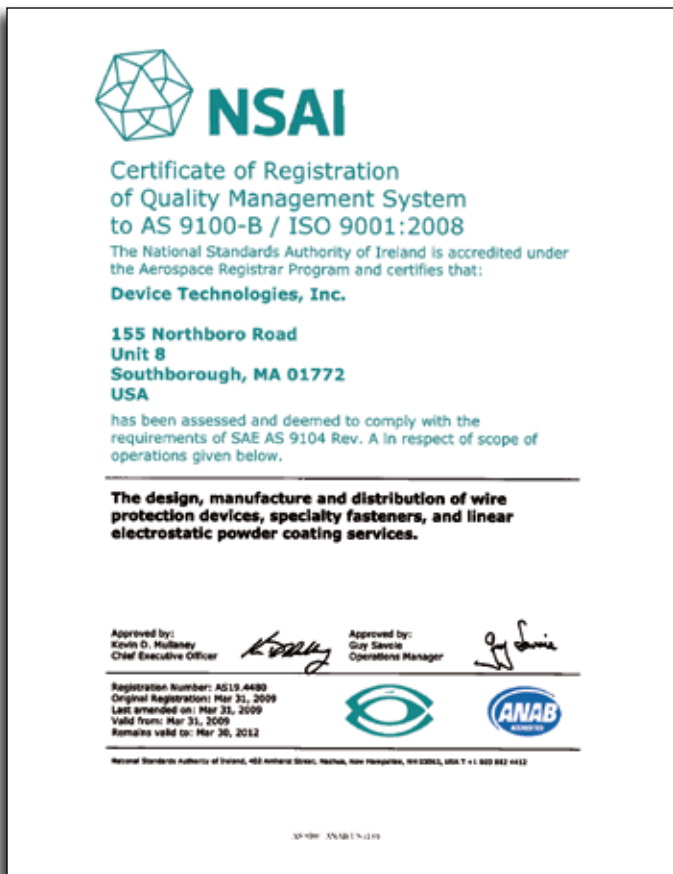

SpringFast®

Wire Protection Grommet Edging and Trim

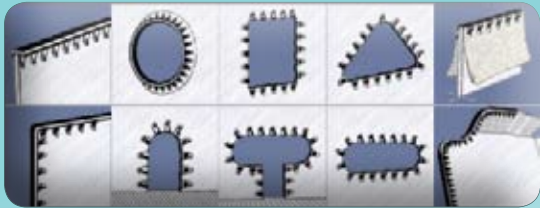

Spring-Fast



Spring-Fast SL Series

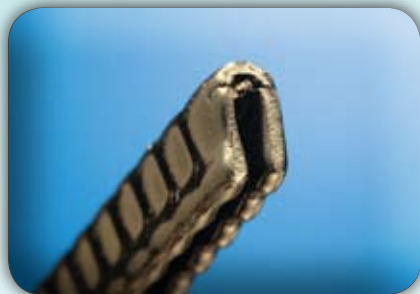

Spring-Fast Mil-Spec



Trim-Fast™ S Series



Spring-Fast is the fastest, safest, most reliable way to protect wires, cables, and tubing from abrasion. It locks on with finger pressure in seconds, eliminating solvents, adhesives, ancillary materials and volatile organic compound (VOCs). Spring-Fast installs continuously and is very flexible for use on sharp corners and curved edges, such as flanged holes.



AP and BAP Series



BT Series

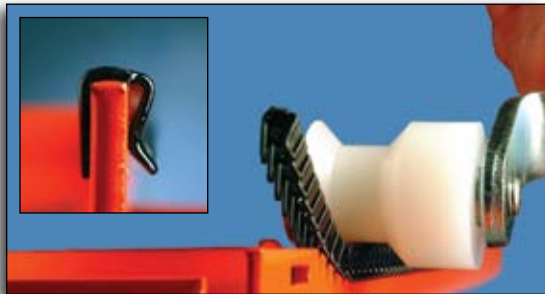

FM Series



BAP Series White

Features for all Spring-Fast:

- Coated with abrasion resistant nylon thermoplastic
- UL94 V-0 flammability rating
- RoHS and FAR 25.853 compliant
- Eliminates adhesives and ancillary
- UV Resistant
- For use on a wide range of panel thicknesses

Spring-Fast "T" Series:

- Lowest profile (size) grommet
- Operating temperature range: -40°F to 285°F (-40°C to 140°C)
- For straight edges and sharp inside and outside corners

Spring-Fast "BT" Series:

- Includes a flexible polymer cushion for added abrasion protection
- Operating temperature range: -40°F to 185°F (-40°C to 85°C)
- For straight edges and sharp inside and outside corners

Spring-Fast "AP" Series:

- Greater gripping strength for severe shock and vibration environments
- Operating temperature range: -40°F to 285°F (-40°C to 140°C)
- Multi-axis flexibility for straight edges, rounded inside and outside corners, and flanged holes

Spring-Fast "BAP" Series:

- Greater gripping strength for severe shock and vibration environments
- Includes a flexible polymer cushion for added abrasion protection
- Operating temperature range: -40°F to 185°F (-40°C to 85°C)
- Multi-axis flexibility for straight edges, rounded inside and outside corners, and flanged holes
- Optional white coating with gray cushion for aerospace applications

Spring-Fast "FM" Series:

- Same characteristics as "AP" Series plus flush mounting on one side for flat panel surfaces
- Operating temperature range: -40°F to 285°F (-40°C to 140°C)
- Multi-axis flexibility for rounded inside and outside corners

Spring-Fast "SLC" Series:

- Completely encapsulated in a flexible UL94 V-0 flame retardant polymer
- Operating temperature range: -40°F to 185°F (-40°C to 85°C)
- Added abrasion protection for wires and hands

Multi-Axis Flexibility:

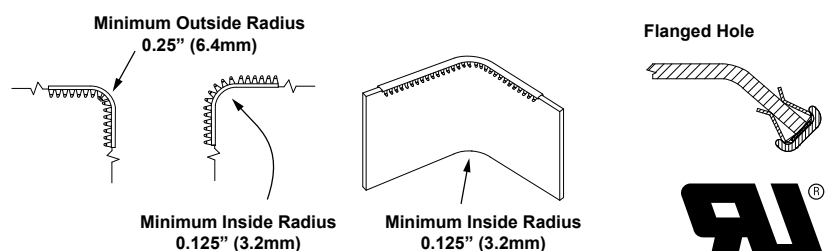

Qualifications:

Spring-Fast Product Configurations	T	AP	FM	BT	BAP	SLC*
Axis Conformity	Single	Multi	Multi	Single	Multi	Multi
Vicat Softening Point per ASTM D01525 Rate B	Substrate Finish: ISO306 356°F (180°C)			TPE Cushion: ISO306 230°F (110°C)		
Operating Temperature Range	-40°F to 285°F (-40°C to 140°C)			-40°F to 185°F (-40°C to 85°C)		
Dielectric Strength Volts 60Hz NASM22529 Section 3.2.1	1000			1500		
Substrate	Stainless Steel					Steel
Taber Abrasion Resistance	Nylon per NFT 30-015 5mg to 8mg loss, 100 cycles			TPE Cushion per D1044 1 KG load C17 Wheel 25mg loss, 1000 cycles		
Finish (End Code)	Epoxy Blue (03) Epoxy Green (06) Nylon Black (02)		Epoxy White (07) FDA White (04)		TPE Cushion Black (01) Gray (02)	
Salt Spray Hours	2000					
Immersion	Per NASM22529 and Skydol Compatible					-
Random Shock and Vibration	MIL-STD-1344, Method 2005.1 Test Condition V1, Letter J Duration 8 hours longitudinal and 8 hours perpendicular. rms G 41.7					
Flammability	UL94 V-0 File No. E113553 NZMT2 • MIL-STD-202F, Method 111A • FAR 25.853 • Telcordia GR-63-CORE					UL94 V-0
Fabrication Options	Factory pre-cut lengths • Bulk or private branded kits Roll-Fast™ installation tool • Bench mounted cut-off press					

Sizes:

* SLC Coming Soon

Product Size	Panel Thickness		Product Color Code	Width Inches (mm)					
	Inches (mm)	Gauge		AP/FM	AP	T	FM	BT	BAP
0	0.020 - 0.030 (0.5 - 0.8)	24, 23, 22, 21	Lt. Purple	0.13 (3.3)		N/A	0.19 (4.8)		
1	0.029 - 0.045 (0.7 - 1.1)	20, 19, 18	White			N/A			
2	0.044 - 0.056 (1.1 - 1.4)	17, 16	Pink			0.14 (3.6)			
3	0.055 - 0.069 (1.4 - 1.7)	15, 14	Yellow	0.18 (4.6)		N/A	0.23 (5.8)	0.28 (6.8)	0.23 (5.8)
4	0.069 - 0.090 (1.7 - 2.3)	13, 12	Blue			N/A			
5	0.089 - 0.114 (2.3 - 2.9)	11, 10, 9	Green			N/A			
6	0.113 - 0.130 (2.9 - 3.3)	8	Orange	N/A	0.25 (6.4)	N/A	0.32 (8.1)	N/A	N/A
7	0.180 - 0.204 (4.6 - 5.2)	5, 4	N/A	N/A	0.32 (8.1)	N/A	0.38 (9.6)	N/A	N/A
8	0.240 - 0.260 (6.1 - 6.6)	2	N/A	N/A		N/A			

Spring-Fast Profiles:

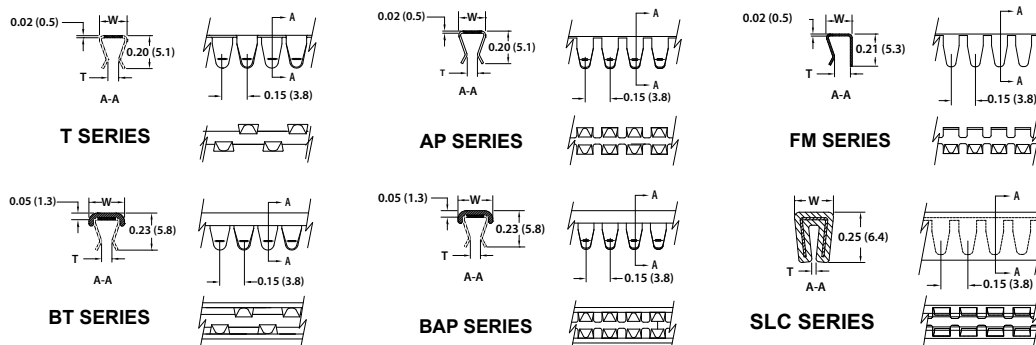

Ordering Examples:

T Series on Reel

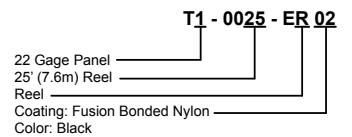

BT Series Factory Precut

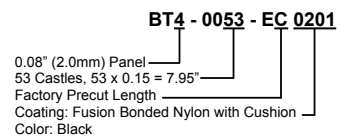

Mil Spec qualified Spring-Fast is the fastest, safest, most reliable way to protect wires, cables, and tubing from abrasion. It locks on with finger pressure in seconds, eliminating solvents, adhesives, ancillary materials and volatile organic compound (VOCs). Installs continuously and is very flexible for use on straight edges and sharp inside and outside corners.



M22529/1



M22529/2

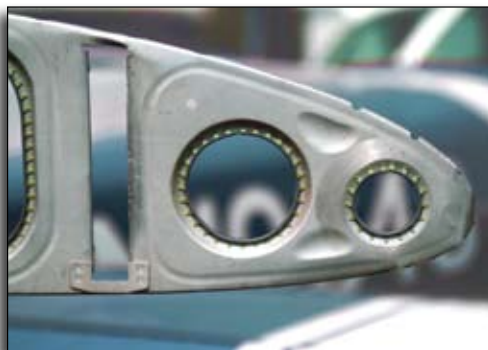

Features and Benefits:

- NASM22529 qualified
- FAA approved
- Eliminates adhesives
- Eliminates major environmental and safety concerns
- Adapts to a wide range of material thicknesses and applications
- For straight edges and inside and outside corners
- FAR 25.601, FAR 25.853, Cage Code: 0HES0
- UL94 V-0 compliant
- RoHS compliant
- National stock numbers available
- Mil Spec Cage Code 0HES0

Applications:

- Airframe Structure
- Military Tactical Vehicles
- Auxiliary Power Units
- Avionic Instruments
- In-flight Entertainment
- Bulkheads
- Seating
- Dashboard
- Lightning Holes
- Tail Section
- Radar Systems
- Flight Refueling
- Land and Armaments
- Wing Ribs

Qualifications:

	M22529/1	M22529/2
Temperature Range	-40°F to 285°F (-40°C to 140°C)	-40°F to 185°F (-40°C to 85°C)
Voltage Breakdown 60 Hz	1500 V	
Flammability	FAR 25.601, FAR 25.853 MIL-STD-202F Method 111A	
Random Shock and Vibration	MIL-STD-1344 Method 2005.1 Test Condition VI, Letter J Overall rms G 41.7	
Salt Spray Testing	2000 hours minimum MIL-STD-202F Method 101D	



Part Numbers

Military Standard		MIL-STD Cross Reference	Sheet Thickness A		Unit Length L		Width B		DTi Cage Code 0HES0 Part Number			
Part Number	Dash Variation		Inches	mm	foot	m	Inches	mm				
M22529/1	-1R-25	MS21266-1 0.015"-0.052"	0.025	0.60	25	7.6	0.14	3.56	T1-0025	-ER0602		
	-1R-100		0.036	0.90	100	30.5			T1-0100			
	-2R-25	MS21266-2 0.052"-0.085"	0.036	0.90	25	7.6			T2-0025			
	-2R-100		0.063	1.60	100	30.5			T2-0100			
	-3R-25		0.059	1.50	25	7.6			T3-0025			
	-3R-100	0.074	1.90	100	30.5	T3-0100						
	-4R-25	MS21266-3 0.085"-0.128"	0.070	1.80	25	7.6	0.19	4.83	T4-0025			
	-4R-100		0.093	2.40	100	30.5			T4-0100			
	-5R-25		0.090	2.30	25	7.6			T5-0025			
	-5R-100		0.111	2.80	100	30.5			T5-0100			
	-6R-25	MS21266-4 0.128"-0.192"	0.105	2.70	25	7.6	0.25	6.35	T6-0025			
	-6R-100		0.134	3.40	100	30.5			T6-0100			
	-7R-25	MS21266-5 0.192"-0.255"	0.178	4.50	25	7.6	0.32	8.13	T7-0025			
	-7R-100		0.198	5.00	100	30.5			T7-0100			
	-8R-25	MS21266-5 0.192"-0.255"	0.240	6.10	25	7.6	0.32	8.13	T8-0025			
	-8R-100		0.260	6.60	100	30.5			T8-0100			
	-nC-85	-	-	-	12.75"	324mm	-	-	Tn-0085		-EC0602	
	M22529/2	-1R-25	MS21266-1 0.015"-0.052"	0.025	0.60	25	7.6	0.20	5.10		BT1-0025	-ER0602
		-1R-100		0.036	0.90	100	30.5				BT1-0100	
		-2R-25	MS21266-2 0.052"-0.085"	0.036	0.90	25	7.6				0.24	
-2R-100		0.063		1.60	100	30.5	BT2-0100					
-3R-25		0.059		1.50	25	7.6	BT3-0025					
-3R-100		0.074	1.90	100	30.5	BT3-0100						
-4R-25		MS21266-3 0.085"-0.128"	0.070	1.80	25	7.6	0.24	6.10	BT4-0025			
-4R-100			0.093	2.40	100	30.5			BT4-0100			
-5R-25			0.090	2.30	25	7.6			BT5-0025			
-5R-100			0.111	2.80	100	30.5			BT5-0100			
-6R-25		MS21266-4 0.128"-0.192"	0.105	2.70	25	7.6	0.32	8.10	BT6-0025			
-6R-100			0.134	3.40	100	30.5			BT6-0100			
-7R-25		MS21266-5 0.192"-0.255"	0.178	4.50	25	7.6	0.38	9.70	BT7-0025			
-7R-100			0.198	5.00	100	30.5			BT7-0100			
-8R-25		MS21266-5 0.192"-0.255"	0.240	6.10	25	7.6	0.38	9.70	BT8-0025			
-8R-100			0.260	6.60	100	30.5			BT8-0100			
-nC-85		-	-	-	12.75"	324mm	-	-	BTn-0085	-EC0602		
MFE-100		Full Bypass Shears								#830		

Cut Lengths

Nominal Hole Diameter Reference	Cut Lengths	
	L Length	Number of Castles
2.000	6.00	40
2.250	6.90	46
2.500	7.65	51
2.750	8.40	56
3.000	9.15	61
3.250	10.05	67
3.500	10.80	72
3.750	11.55	77
4.000	12.30	82
4.250	13.20	88
4.500	13.95	93
4.750	14.70	98
5.000	15.45	103
5.250	16.35	109
5.500	17.10	114
5.750	17.85	119
6.000	18.60	124

Dimensions in inches per NASM22529

Ordering Examples

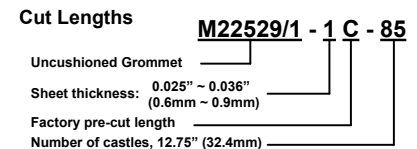
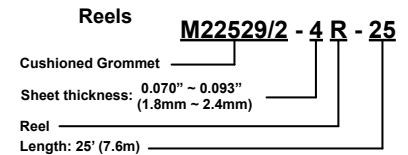

Due to sheet thickness tolerances and finishes, end user should determine product sizes by trial. When sheet thickness is at the maximum for the grommet chosen, end user may use a rubber mallet to set, or try the next size larger grommet.

M22529/1 Grommet

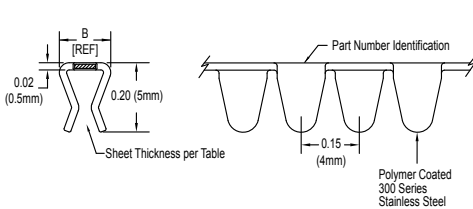

M22529/2 Grommet

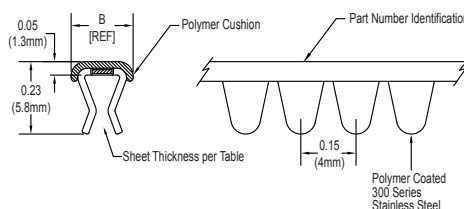

Ordering Options:

- 25' (7.6m) or 100' (152m)
- Factory pre-cut lengths
- Bulk or private branded kits
- 840R Roll-Fast™ installation tool
- MFE-100 Full Bypass Shears
- 860GSB Spring-Fast® Cut to Length Scale

SpringFast® SL AERO Series

Wire Protection Grommet Edging

Spring-Fast SL AERO Series is the fastest, safest, most reliable way to protect wires, cables, and tubing from abrasion. It locks on with finger pressure in seconds, eliminating solvents, adhesives, ancillary materials, and volatile organic compound (VOCs). SL AERO installs continuously and is very flexible for use on curved edges, such as flanged holes. The SL AERO Series is fully encapsulated in a flexible polymer for added abrasion protection for use on high performance applications including aircraft structures and interiors, advanced avionics systems, military vehicles, NASCAR, super computers, medical equipment, and rail transit.



Qualifications:

- Flammability per FAR 25.853 and ASTM E 162 (UL94 V-0)
- Smoke Density per ASTM E 662
- Random Vibration per MIL-STD-102, Method 214A, Table 1
- Mechanical Shock per MIL-STD-810C, Method 516.2
- Salt Spray (Corrosion) per MIL-STD-202F, Method 101D
- Humidity per MIL-STD-810F, Method 507.4
- Immersion per NASM22529, Paragraph 4.2.5
- Dielectric Withstanding Voltage per NASM22529, Paragraph 4.2.5
- Low Temperature per MIL-STD-810E, Method 502.3
- Temperature Cycling per MIL-STD-202G, Method 107G, Table 107-1



Features and Benefits:

- RoHS compliant
- DFARS Compliant
- Multi axis flexibility for straight edges, flanged holes, and inside and outside corners
- Indoor and outdoor use
- Operating temperature range: -67°F to 203°F (-55°C to 95°C)
- Continuous edge protection
- Excellent gripping strength
- Excellent resistance to abrasion, water absorption, and low and high temperatures
- Fast assembly without the use of adhesives, rivets, or screws

Applications:

- Aerospace
- Military
- Automotive
- Telecommunication
- Medical
- General Industrial
- Railway

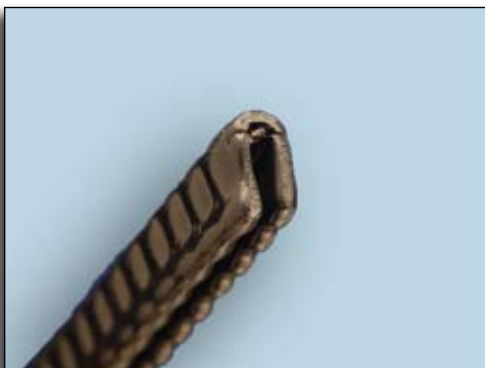

SL AERO Series SpringFast® Wire Protection Grommet Edging

Qualifications:

Description	Specification	Test Standard
Axis Conformity	Multi	-
Substrate	Stainless Steel	ASTM A 666-03
Color	Black	-
Vicat Softening Point	ISO306 230°F (110°C)	ASTM D01525 Rate B
Operating Temperature Range	-67°F to 203°F (-55°C to 95°C)	MIL-STD-202G, Method 107G, Table 107-1
Low Temperature Soak	-40°F (-40°C)	MIL-STD-810E, Method 502.3
Temperature Cycling	-67°F to 203°F (-55°C to 95°C)	MIL-STD-202G, Method 107G, Table 107-1
Humidity	No physical change	MIL-STD-810F, Method 507.4 & Figure 507.4-1
Dielectric Withstanding Voltage	2000 volts @ 60Hz	NASM22529 Paragraph 4.2.9
Abrasion Resistance	25 mg Loss	ASTM D1044 1Kg Load, C17 Wheel @ 1000 cycles
	No change in weight or dielectric strength	DTi Abrasion Resistance Test 250,000 cycles @ 60 cycles/min.
Salt Spray Hours	3000	ASTM B117. MIL-STD-202, Method 301
Immersion	No physical change	NASM22529 and Skydrol Compatible
Mechanical Shock	No movement or physical change	MIL-STD-810C Method 516.2 Test Procedure IV Drop Test @ 100 g force per 3 perpendicular axes
Random Vibration	No movement or physical change	MIL-STD-202 Method 214A Table, Duration: 8 hours in 3 perpendicular axes over GRMS 39
Flammability	No sustained flame front or drips on test floor	ASTM E 162, FAR 25, UL94 V-0
Smoke Density	Test period 90 sec., 4 min., 20 min. with no flaming, dripping, or running	ASTM E 662, FAR 25
Flammability Certifications	FAR 25.853	UL94 V-0 (File No. E113553 NZMT2)

Sizes:

Product Size	Sheet Thickness "T"		Width "W"	
	Inches	(mm)	Inches	mm
0	0.020 - 0.030	(0.5 - 0.8)	0.19	(4.8)
1	0.029 - 0.045	(0.7 - 1.1)		
2	0.044 - 0.056	(1.1 - 1.4)		
3	0.055 - 0.069	(1.4 - 1.7)		
4	0.069 - 0.090	(1.7 - 2.3)	0.23	(5.8)
5	0.089 - 0.114	(2.3 - 2.9)		
6	0.113 - 0.130	(2.9 - 3.3)		
6MA	0.135 - 0.145	(3.4 - 3.7)		

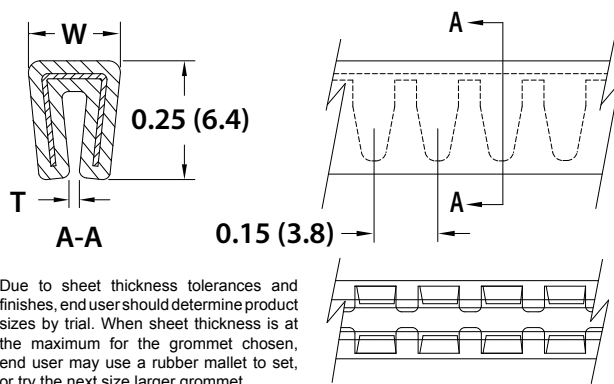

Ordering Examples

SL Series on Reel

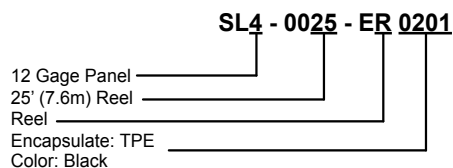

SL Series Factory Precut

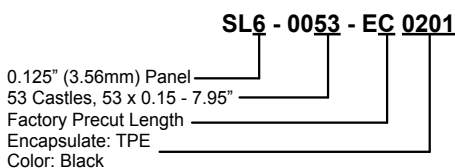

Additional Ordering Options:

- Color coating available
- 25' (7.6m), 100' (30.4m), 500' (152m) reels
- Factory pre-cut lengths
- #840RS Roll-Fast™ installation tool
- #830PS Full Bypass Shears
- #860GSB Spring-Fast Cut to Length Scale

A better, cleaner, and faster way to cover sharp panel edges and protect your equipment from failure due to wire, cable, or hose abrasion and create a finished edge appearance. Trim-Fast is offered in enlarged sizes for thicker panel applications up to 3/4" (19mm).

Trim-Fast Edge Trim is available in a variety of materials, which include a flexible steel or stainless steel substrate covered with Silicone, EPDM, or PVC allowing for fast and easy assembly.

Features and Benefits:

- Excellent grip strength
- Excellent resistance to abrasion
- Low and high temperature use
- Indoor and outdoor use
- Fast assembly without the use of adhesives, rivets, or screws
- Multi-axis flexibility for straight edges, or small radii
- Sheet thickness ranges from 0.039" (1mm) up to 3/4" (19mm)

Applications:

- Automotive
- Railway
- Aerospace
- Food service (FDA white)
- Telecommunications
- Construction
- Marine
- General industrial



"S" Silicone Series

- FDA approved (White Silicone Material)
- ASTM E 662 (Toxicity)
- ASTM C 542 & ASTM C 1166 (Flame Propagation)



"S" EPDM Series

- FMVSS 302 (Flammability of Interior Materials)
- SAE J1885 (Interior Weatherometer)
- SAE J1960 (Exterior Weatherometer)
- SAE 200 M8BA 708 B13 21-6 (Low Temperature Flexibility)



"S" PVC Series

- Greater flexibility for small corner radii
- Smaller profile

Trim-Fast Specifications and Ordering Options

Trim-Fast Seal Product Configurations		PVC	EPDM	Silicone	
Substrate (Base Material)		Steel Clip	Steel Wire (Optional: Stainless Steel Wire)	Stainless Steel	
Gasket Material	Type	PVC	EPDM	Silicone	FDA Approved Silicone
	Durometer	Shore A 65	Shore A 70 (Optional: 50 and 90)	Shore A 90 (Optional: 45 and 60)	
	Color	Black	Black	Black	White
Operating Temperature Range		Up to 212°F (100°C)	-40°F to 350°F (-40°C to 177°C)	-50°F to 450°F (-45°C to 232°C)	
Interior Weatherometer			SAE J1885		
Exterior Weatherometer			SAE J1960		
Low Temperature Flexibility			SAE J200 M8BA 708 B13 Z1-6		
Flame Propagation - Rail & Aero				ASTM C 542, ASTM C1166	
Flammability of Interior Materials (Burn Resistance) - Automotive			FMVSS 302		
Toxicity - Rail & Aero				BSS 7239, ATS 100/ABD0031 ASTM E 662 & METHOD D 2036-91	
Food Service Equipment				FDA Approved White	
Fabrications Options		Factory pre-cut lengths, bulk, or private branded kits			
RoHS Compliant		YES	YES	YES	

Trim-Fast Standard Profiles

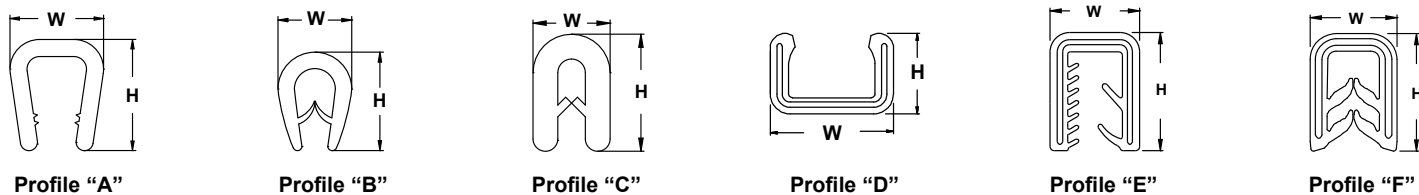

Part Number	Substrate Material	Gasket Material	Profile	Gasket Width "W" inches (mm)	Gasket Height "H" inches (mm)	Application Thickness inches (mm)
S6-009-S02	Steel	Flexible PVC	A	0.512 (13.0)	0.591 (15.0)	0.236-0.315 (6.0-8.0)
S2-003-S02	Steel	Flexible PVC	B	0.256 (6.5)	0.374 (9.5)	0.039-0.079 (1.0-2.0)
S3-005-S02	Steel	Flexible PVC	B	0.354 (9.0)	0.472 (12.0)	0.039-0.118 (1.0-3.0)
S1-004-S02	Steel	Flexible PVC	C	0.220 (5.6)	0.335 (8.5)	0.039 (1.0)
S10-015-T04	Stainless	Silicone	D	1.107 (28.1)	0.431 (10.9)	0.75 (19.1) Nom.
S7-014-S01	Steel	EPDM	D	0.732 (18.6)	0.618 (15.7)	.375 (9.53) Nom.
S7-015-S01	Steel	EPDM	D	0.732 (18.6)	0.393 (9.98)	.375 (9.53) Nom.
S7-016-S01	Steel	EPDM	D	0.732 (18.6)	0.453 (11.5)	.375 (9.53) Nom.
S8-007-S01	Steel	EPDM	D	0.732 (18.6)	0.608 (15.4)	0.5 (12.7) Nom.
S9-006-S01	Steel	EPDM	D	0.926 (23.5)	0.607 (15.4)	0.625 (15.9) Nom.
S6-010-S01	Steel	EPDM	E	0.539 (13.74)	0.716 (18.2)	0.25 (6.35) Nom.
S3-001-S04	Steel	Silicone	F	0.394 (10.0)	0.563 (14.3)	0.040-0.125 (1.0-3.18)
S3-002-S01	Steel	EPDM	F	0.394 (10.0)	0.563 (14.3)	0.040-0.125 (1.0-3.18)
S5-008-S02	Steel	Flexible PVC	F	0.453 (11.5)	0.669 (17.0)	0.157-0.236 (4.0-6.0)

Additional and custom sizes available, please consult factory or representative for details or evaluation samples

DTi offers a variety of tools to cut, measure, and apply Spring-Fast grommet and Trim-Fast edge trim.



Full Bypass Shears - Part Number 830PS

- Quickly cuts Spring-Fast grommet and Trim-Fast edge trim assuring a clean, burr-free cut
- Prevents distortion of adjacent castles

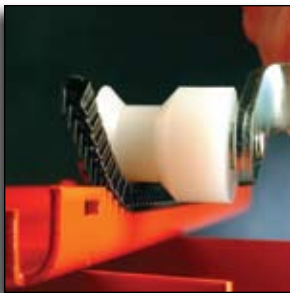

Roll-Fast™ - Part Number 840R

- Quickly installs Spring-Fast grommet
- 1/2" (12.7mm) outside groove diameter



Cutter-Cart® - Part Number 850CS

- Two fixed and two swivel casters with brakes
- Mounting shaft to install up to (16) 25' rolls or (6) 100' reels
- Cutting bar with 830PS shears
- Cut to length scale
- Lower tray for additional inventory



Spring-Fast Cut to Length Scale - Part Number 860GSB

- Adhesive backed for applying to work bench
- Measures in inches and castles
- 24 inches long (154 castles)



Spring-Fast Sheet Thickness Gauge - Part Number 880-G

- Go/No Go Gauge for all Spring-Fast sizes
- For sheet thicknesses from 0.020" to 0.260" (0.5mm - 6.6mm)
- Made from stainless steel

Seal-Fast™

High Performance Enclosures and Door Seals



A better, cleaner, and faster way to protect your equipment from environmental conditions; dust, low and high temperatures, and moisture.

The Seal-Fast Edge Seal installs without the use of adhesives, is very flexible, and is available in a variety of materials which include a flexible steel or stainless steel substrate with a Silicone, EPDM, or PVC gasket allowing for fast assembly.

Features and Benefits:

- Fast assembly without the use of adhesives, rivets, or screws
- Excellent grip strength
- Multi-axis flexibility for small inside and outside radius corners
- Excellent resistance to abrasion, water absorption, and low and high temperatures
- Indoor or outdoor use

Applications:

- Automotive
- Railway
- Aerospace
- Food service (FDA white)
- Telecommunication
- Construction, mining, and forestry
- General industrial



“D” Silicone Series

- FDA approved (White Silicone Material)
- ASTM E 662 (Toxicity)
- ASTM C 542 & ASTM C 1166 (Flame Propagation)



“D” EPDM Series

- FMVSS 302 (Flammability of Interior Materials)
- SAE J1885 (Interior Weatherometer)
- SAE J1960 (Exterior Weatherometer)
- SAE 200 M8BA 708 B13 21-6 (Low Temperature Flexibility)



“D” PVC/EPDM Series

- Greater flexibility for small corner radii
- Smaller profile

Seal-Fast Specifications and Ordering Options

Seal-Fast Seal Product Configurations		PVC/EPDM	EPDM	Silicone	
Substrate (Base Material)		Steel Clip	Steel Wire (Optional: Stainless Steel Wire)	Stainless Steel (Optional: Steel Wire)	
Gasket Material	Type	PVC	EPDM	Silicone	FDA Approved Silicone
	Durometer	Shore A 65	Shore A 70 (Optional: 50 and 90)		Shore A 90 (Optional: 45 and 60)
	Color	Black	Black	Black	White
Seal Material (Top or Side Bulb)	Type	EPDM	EPDM	Silicone	FDA Approved Silicone
	Durometer	Shore A 65	Sponge Rubber (EPDM)		Shore A 70 (Optional: 45 and 60)
	Color	Black	Black	Black	White
Operating Temperature Range		Up to 212°F (100°C)	-40°F to 350°F (-40°C to 177°C)		-50°F to 450°F (-45°C to 232°C)
Interior Weatherometer			SAE J1885		
Exterior Weatherometer			SAE J1960		
Low Temperature Flexibility			SAE J200 M8BA 708 B13 Z1-6		
Flame Propagation - Rail & Aero					ASTM C 542, ASTM C1166
Flammability of Interior Materials (Burn Resistance) - Automotive			FMVSS 302		
Toxicity - Rail & Aero					BSS 7239, ATS 100/ABD0031 ASTM E 662 & METHOD D 2036-91
Food Service Equipment					FDA Approved White
Fabrications Options		Factory pre-cut lengths, bulk, or private branded kits			
RoHS Compliant		YES	YES	YES	

Seal-Fast™ Standard Profiles

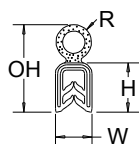

Profile "A"

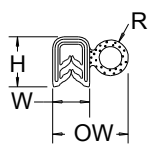

Profile "B"

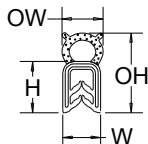

Profile "C"

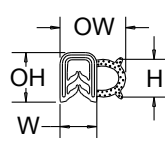

Profile "D"

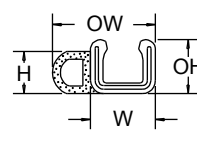

Profile "E"

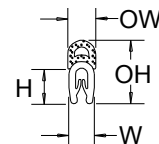

Profile "F"

DTi Part #	Substrate Material	Gasket Material	Seal Material	Seal Config.	Profile	Grommet Width (inches)	Grommet Height (inches)	Overall Width (inches)	Overall Height (inches)	Seal Radius (inches)	Seal Width (inches)	Application Thickness (inches)
D3-001-S011	Steel	EPDM	EPDM	Top	A	0.394	0.532	0.394	0.942	0.19	0.38	0.040-0.125
D3-002-S011	Steel	EPDM	EPDM	Top	A	0.394	0.532	0.59	1.162	0.295	0.59	0.040-0.125
D3-003-S011	Steel	EPDM	EPDM	Top	A	0.394	0.532	0.72	1.292	0.36	0.72	0.040-0.125
D1-020-T04	Stainless	-	Silicone	Side	B	0.18	0.48	0.55	0.48	0.185	0.37	0.062 Nom
D3-004-S011	Steel	EPDM	EPDM	Side	B	0.394	0.532	0.806	0.532	0.19	0.38	0.040-0.125
D4-033-T244	Stainless	Silicone White	Silicone White	Side	B	0.394	0.532	0.92	0.523	0.28	0.525	0.187 Nom.
D3-028-S044	Steel	Silicone	Silicone	Top	C	0.394	0.532	0.55	1.06	0.25	0.5	0.040-0.125
D3-029-T011	Stainless	EPDM	EPDM	Top	C	0.394	0.532	0.43	0.83	0.215	1.43	0.040-0.125
D3-008-S044	Steel	Silicone	Silicone	Top	C	0.394	0.532	0.424	0.847	0.212	0.424	0.040-0.125
D3-010-S011	Steel	EPDM	EPDM	Side	D	0.394	0.532	0.701	0.532	--	0.307	0.040-0.125
D3-023-S011	Steel	EPDM	EPDM	Side	E	0.378	0.532	0.64	0.532	--	0.262	0.040-0.125
D8-012-S011	Steel	EPDM	EPDM	Side	E	0.732	0.608	1.161	0.608	--	0.429	0.500 Nom
D9-027-S011	Steel	EPDM	EPDM	Side	E	0.926	0.607	1.324	0.607	--	0.398	0.531-0.625
D2-016-S021	Steel	Flexible PVC	EPDM	Top	F	0.256	0.311	0.256	0.571	--	0.256	0.029-0.082
D3-015-S021	Steel	Flexible PVC	EPDM	Top	F	0.433	0.484	0.433	0.846	--	0.433	0.040-0.125

Additional and custom sizes & profiles available, please consult factory or representative for details or evaluation samples

Plate-Seal is the fastest, safest, and most reliable way to protect critical equipment in places where wire, cable, air hoses, liquid hoses, and fuel and oil lines pass through openings and are in contact with sharp panel surfaces. The flame resistant Plate-Seal protects against chafing and abrasion, and seals out heat, fumes, dust, moisture, and other contaminants. The rubber grommet portion grips tightly to create an environmental seal that provides a clean and organized appearance. Plate-Seal mounts to a panel using rivets or screws and is offered in stock sizes which can be customized to fit many applications.



Features and Benefits:

- Fast and easy to install with use of screw, rivets, or optional PSA
- Encapsulated with NBR to keep unwanted contaminants from entering through hole or cutout area
- Protects wire, cables, and hoses from chafing and abrasion
- Enhances appearance
- No need for extended cure time adhesives or other auxiliary material
- Accepts a wide range of cable diameters
- UV and ozone resistant
- Excellent resistance to abrasion, compression set, flex cracking, impact, tear, and vibration

Applications:

- Aircraft galley equipment
- Avionics
- Bulkhead
- Automotive
- Railway
- Telecommunications
- Marine
- Trailers and motor homes
- General industrial



Performance:

- Resistant to fluids (solvents, fuels, and oils) per MIL-R-3065D, MIL-R-6855, and MIL-R-2765
- Continuous operating temperature: -50°F to 320°F (-45°C to 160°C)
- Intermittent operating temperature: -70°F to 400°F (-57°C to 204°C)
- Durometer range: 20 to 95 Shore A
- Elongation range: 350% to 650%



Product Sizes per Product Type:

- For hole diameters and cutouts from 1" to 5" (25.4mm to 127mm)
- For standard cable bundles or hose diameters from 0.25" to 1.5" (6.4mm to 38.1mm)
- Choose seal inside diameter that is 1/16" to 1/8" (1.59mm to 3.18mm) smaller than bundle/hose diameter.
- Largest bundle/hose diameter should be at least 3/8" (9.53mm) less than seal outside diameter.
- Custom solutions per application

Plate-Seal Specifications and Ordering Options

Seal Types

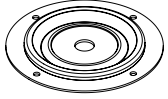

"A" Single Seal

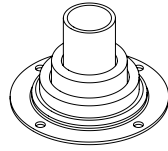

"B" Bellow Seal

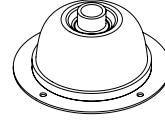

"C" Dome Seal

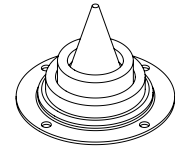

"D" Pointed Bellow Seal

Standard Dimensions

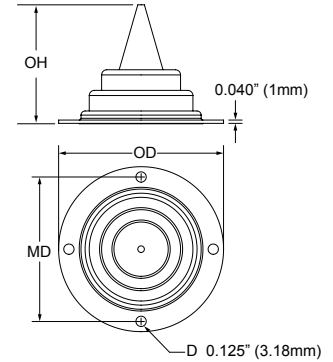
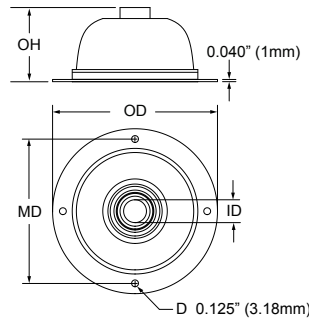
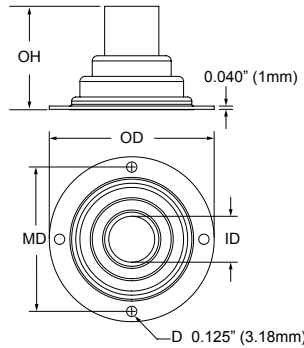
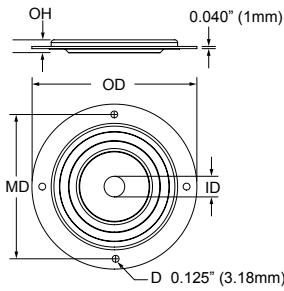

Part Numbers

DTi z Part Number	Seal Type	"OD" Overall Diameter		"OH" Overall Height		"ID" Seal Inside Diameter		Seal Outside Diameter		Seal Height		"MD" Mounting Hole Distance	
		inches	mm	inches	mm	inches	mm	inches	mm	inches	mm	inches	mm
PS-1.5-A-BL	A	1.5	38.1	0.16	4.1	N/A	N/A	1.00	25.4	0.12	3.0	1.25	31.8
PS-2.0-A-BL		2.0	50.8	0.16	4.1	N/A	N/A	1.55	39.4	0.12	3.0	1.75	44.5
PS-3.0-A-BL		3.0	76.2	0.16	4.1	N/A	N/A	2.25	57.2	0.12	3.0	2.625	66.7
PS-3.0-A-25		3.0	76.2	0.16	4.1	0.25	6.4	2.25	57.2	0.12	3.0	2.625	66.7
PS-3.0-A-38		3.0	76.2	0.16	4.1	0.375	9.5	2.25	57.2	0.12	3.0	2.625	66.7
PS-3.0-A-50		3.0	76.2	0.16	4.1	0.50	12.7	2.25	57.2	0.12	3.0	2.625	66.7
PS-3.0-A-63		3.0	76.2	0.16	4.1	0.625	15.9	2.25	57.2	0.12	3.0	2.625	66.7
PS-3.0-A-75		3.0	76.2	0.16	4.1	0.75	19.1	2.25	57.2	0.12	3.0	2.625	66.7
PS-3.0-A-95		3.0	76.2	0.16	4.1	0.95	24.1	2.25	57.2	0.12	3.0	2.625	66.7
PS-3.0-A-118		3.0	76.2	0.21	5.3	1.18	30.0	2.385	60.6	0.17	4.3	2.625	66.7
PS-4.0-A-BL		4.0	101.6	0.10	2.5	N/A	N/A	3.0	76.2	0.06	1.5	3.625	92.1
PS-4.0-A-100		4.0	101.6	0.10	2.5	1.0	25.4	3.0	76.2	0.06	1.5	3.625	92.1
PS-4.0-A-180		4.0	101.6	0.10	2.5	1.8	45.7	3.0	76.2	0.06	1.5	3.625	92.1
PS-4.5-A-150		4.5	114.3	0.29	7.4	1.5	38.1	3.4	86.4	0.25	6.4	4.0	101.6
PS-4.5-A-212		4.5	114.3	0.29	7.4	2.12	53.8	3.4	86.4	0.25	6.4	4.0	101.6
PS-6.0-A-BL		6.0	152.4	0.10	2.5	N/A	N/A	5.0	127	0.06	1.5	5.5	139.7
PS-2.0-B-42	B	2.0	50.8	1.15	29.2	0.416	10.6	1.2	30.5	1.11	28.2	1.75	44.5
PS-3.0-C-42	C	3.0	76.2	1.35	34.3	0.416	10.6	2.062	52.4	1.31	33.3	2.625	66.7
PS-1.5-D-BL	D	1.5	38.1	0.64	16.3	N/A	N/A	0.50	12.7	0.60	15.2	1.25	31.8
PS-2.0-D-BL		2.0	50.8	0.50	12.7	N/A	N/A	0.8	20.3	0.46	11.7	1.75	44.5



Cutting Saw - Part Number 910JS

- Thin blade cuts all seal material including metal
- Ergonomic handle
- Highly adjustable for easy blade changes



Roll-Fast™ - Part Number 840R

- Quickly installs seal and trim materials
- 1/2" (12.7mm) outside groove diameter for smaller size profiles



Long-Nose Full Bypass Shears - Part Number 830LN

- Quickly cuts seal material for rough cut lengths
- Larger profiles may require more than one cut
- Easily cuts through metal carrier

Other installation and tool options:

- Use band saw for cutting to length or finishing edges
- Use larger, flat roller for profiles greater than 1/2" (12.7mm) wide
- Use rubber mallet for installing tighter fitting profiles

Cable Management



Fast-Drop™
Fiber Bend Radius
Control Modules



Protect-Fast™
Braided Sleeving



DTi-Tis™
Hook and Loop Straps



DTi-Tis™
Specialty Cable Ties



The Push-Mount Cable Tie System is designed for fast and easy assembly with no need for mechanical fastener reducing installation time and costs. It quickly secures and positions wire bundles, cables, and hoses, to panels. Extra stability is created from the push mount head design, which is contained, keeping cable ties from sliding during installation and application. The cable tie has a low profile height compared to standard designs increasing safety and eliminating snags, and cuts and abrasions to wires, cables, and hoses. The cable tie can be removed and replaced fast and easily by cutting the top crossbar.



Features and Benefits:

- Reduction of installation time and its associated costs
- Low-profile, tamper-proof cable tie
- Rated for indoor and outdoor use
- Flame retardant per UL94 V-2
- RoHS compliant
- Tensile strength: 50lb (222N)
- Operating temperature range: -40°F to 185°F (-40°C to 85°C)

Applications:

- Cell towers
- Aerial support
- Telecommunications
- Transportation



Part Number: 0501-01

Tolerances: .xxx = ±0.005, .xx = ±0.015

Packaging: Sealed poly bag in quantities of 100, 1000, or customer specified up to 1000 pieces

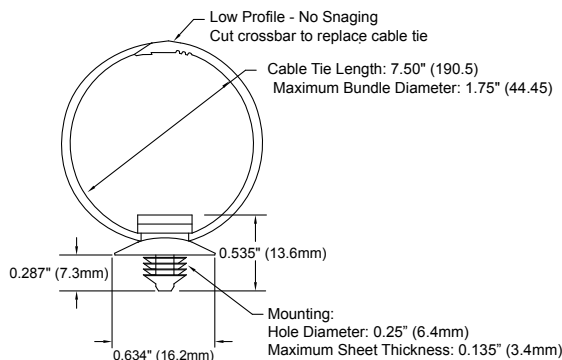

DTi-Ti Push-Mount Cable Ties

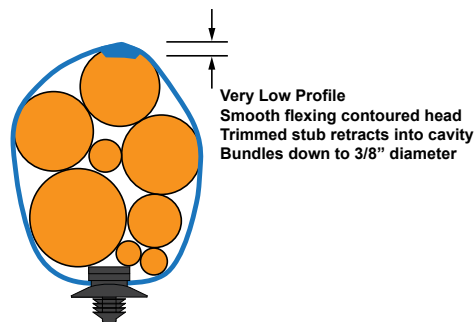

Standard

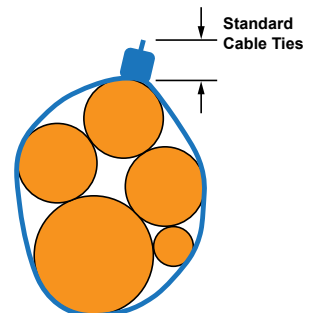

The Pull-Mount cable tie installs from the bottom of the panel. The high strength button head snaps fast and easily into a 3/8" (9.5 mm) diameter hole inside a panel with a thickness range from 0.045" (1.1 mm) to 0.100" (2.5 mm). The cable tie loops around the cables to secure the bundle. The excess cable tie is pushed through the releasable latch mechanism and the retaining tabs to create a secure fit, eliminating the need to cut off excess.

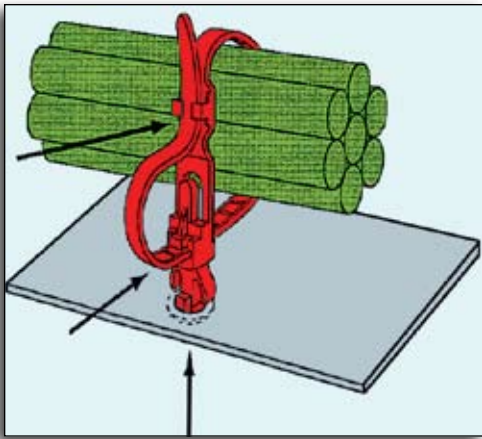

Features and Benefits:

- Fast and easy assembly
- UV resistant for indoor and outdoor use
- Flame retardant per UL94-V2
- RoHS Compliant
- Operating temperature range: -40°F to 221°F (-40°C to 105°C)
- Application hole diameter: 0.375" (9.5mm)
- Application panel range: 0.045" to 0.100" (1.1mm to 2.5mm)
- Maximum bundle diameter: 1.75" (4.44cm)

Applications:

- Aircraft Seating
- Appliances
- Cell Towers
- Aerial Support
- Telecommunications
- Transportation
- General Industrial

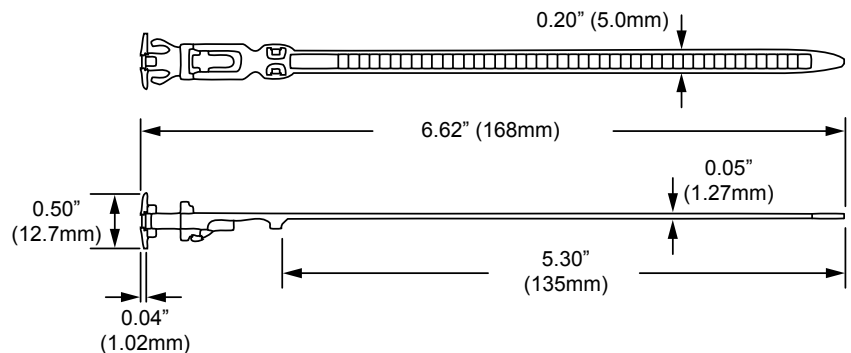
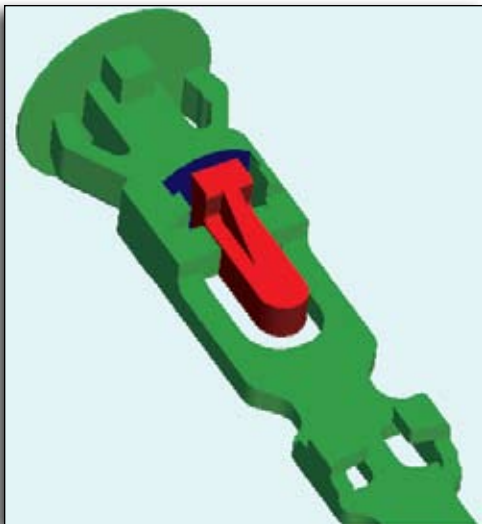

Part Number: 0685-05000-070

Packaging: Sealed poly bag in quantities of 100, 1000, or customer specified up to 1000 pieces

DTI-Ti's are moisturized to maintain optimal performance levels. Cable ties should be stored in cool dry areas, out of direct sunlight, and sealed in the original packaging.

Color Cable Ties

The Color Cable Tie is ideal for color coding, identification, packaging continuity, bundling, and aesthetics applications. They assemble fast and easy and are Mil Spec MS-3367 approved.

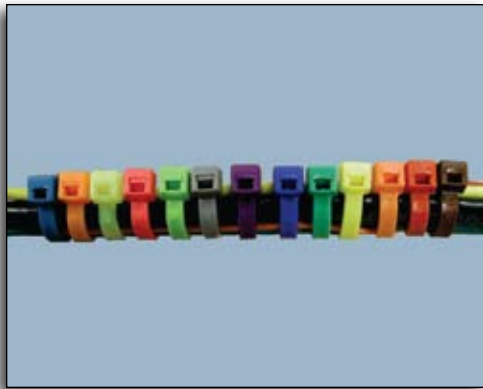

Features and Benefits:

- Fast and easy assembly
- Indoor and outdoor use
- Flame retardant per UL92 V-2
- RoHS compliant
- Operating temperature range: -40°F to 185°F (-40°C to 85°C)
- Mil-Spec approved MS3367

Applications:

- Color coding
- Identification
- Packaging continuity
- Bundling aesthetics
- General industrial

Low Profile Cable Ties

The tamper-proof Low Profile Cable Tie has a low profile head preventing snagging when the cable is trimmed and pulled through a hole. The low profile design eliminates sharp edges, common in most cable ties.



Features and Benefits:

- Fast and easy assembly
- Indoor and outdoor use
- UV (ultraviolet) light resistance
- Flame retardant per UL92 V-2
- RoHS compliant
- Operating temperature range: -40°F to 185°F (-40°F to 85°F)
- Mil Spec approved MS3367
- Color: Black or natural

Applications:

- Cell towers
- Aerial support
- Telecommunications
- Transportation

Color Cable Ties Ordering Options

Color # Codes
1 = Brown
2 = Red
3 = Orange
4 = Yellow
5 = Green
6 = Blue
7 = Purple
8 = Gray
11 = Fluorescent Green
12 = Fluorescent Pink
13 = Fluorescent Yellow
14 = Fluorescent Orange
15 = Fluorescent Blue

DTI P/N	Length inches (mm)	Width inches (mm)	Thickness inches (mm)	Bundle Diameter inches	Tie Tensile lbs.	Mil Spec Reference
0570-0180#-041C	4.1 (104.7)	0.095 (2.413)	0.042 (1.066)	0.875	18	MS3367-4*
0570-0400#-058C	5.8 (148.3)	0.140 (3.556)	0.049 (1.244)	1.437	40	MS3367-5*
0570-0400#-088C	8.8 (225.4)	0.140 (3.556)	0.049 (1.244)	2.375	40	-
0570-0500#-075C	7.5 (192.0)	0.180 (4.572)	0.052 (1.320)	1.875	50	MS3367-1*
0570-0500#-112C	11.2 (285.75)	0.180 (4.572)	0.052 (1.320)	3.062	50	MS3367-7*
0570-0500#-145C	14.5 (369.8)	0.180 (4.572)	0.052 (1.320)	4.125	50	MS3367-2*
0570-1200#-150C	15.0 (383.3)	0.300 (7.620)	0.076 (1.930)	4.06	120	MS3367-3*

*Mil-Spec does not apply to fluorescent colors.
Color #1 and #13 are not available in 14" (120lb) cable tie.

Tolerances: .xxx = ±0.005, .xx = ±0.015

Packaging: Sealed poly bag in quantities of 100, 1000, or customer specified up to 1000 pieces.

Material: Nylon

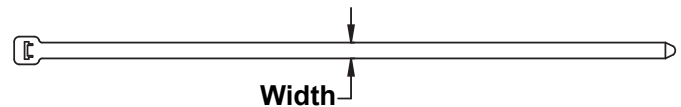
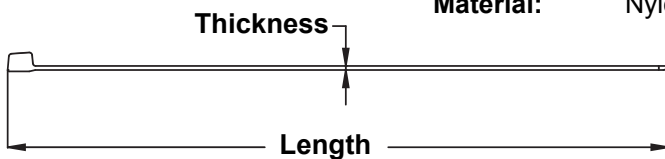

Low Profile Cable Ties Ordering Options

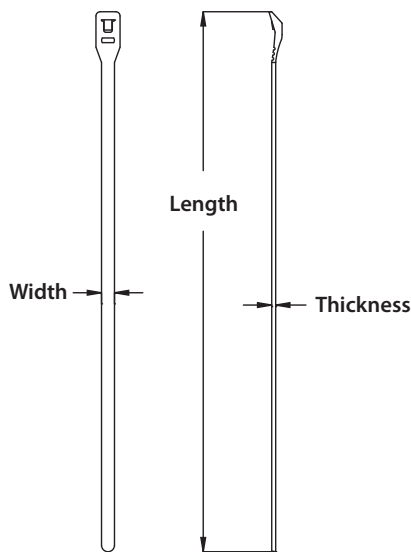

DTI P/N	Length inch (mm)	Width inch (mm)	Thickness inch (mm)	Tie Tensile lbs.	Bundle Diameter inch	Mil-Spec Reference
0500-05009-075M	7.5 (190.5)	0.177 (4.495)	0.053 (1.346)	50	1.75	MS3367-23-9
0500-05009-075C	7.5 (190.5)	0.177 (4.495)	0.053 (1.346)	50	1.75	MS3367-23-9
0500-05000-075M	7.5 (190.5)	0.177 (4.495)	0.053 (1.346)	50	1.75	MS3367-23-0
0500-05000-075C	7.5 (190.5)	0.177 (4.495)	0.053 (1.346)	50	1.75	MS3367-23-0
0500-05009-113C	11.3 (288.2)	0.177 (4.495)	0.053 (1.346)	50	3.06	-
0500-05000-113C	11.3 (288.2)	0.177 (4.495)	0.053 (1.346)	50	3.06	
0500-05009-146C	14.6 (372.1)	0.177 (4.495)	0.053 (1.346)	50	4.06	
0500-05000-146C	14.6 (372.1)	0.177 (4.495)	0.053 (1.346)	50	4.06	

Tolerances: .xxx = ±0.005, .xx = ±0.015

Packaging: Sealed poly bag in quantities of 100, 1000, or customer specified up to 1000 pieces

Material: Nylon

DTI-Ti's are moisturized to maintain optimal performance levels. Cable ties should be stored in cool dry areas, out of direct sunlight, and sealed in the original packaging.

Stainless Steel Cable Ties

The stainless steel cable ties are extra strong and durable, for bundling and fastening applications in severe environmental conditions. Great for industrial projects and network bundling of data and power cables.



Features and Benefits:

- Ball and locking mechanism provides ease of insertion and high tensile strength
- Excellent UV and chemical resistance
- Non-flammable
- Indoor and outdoor use
- Loop tensile strength: 100 lb. and 250 lb.
- Type 304 Stainless Steel
- Color: Uncoated or coated black
- Operating temperature range:
Uncoated:
-112°F to 900°F (-80°C to 482°C)
Coated Black:
-40°F to 302°F (-40°C to 150°C)

Applications:

- Construction
- Landscaping
- Oil rigs
- Chemical plants
- Solar
- Ships/Submarines
- Cell towers
- Aerial support
- Telecommunications
- Transportation

Tefzel Cable Ties

The Tefzel Cable Tie is resistant to radiation, flames, UV (ultraviolet) light, chemicals, and high temperatures with a maximum use temperature of 302°F (150°C).

*Tefzel is a trademark of DuPont Corporation

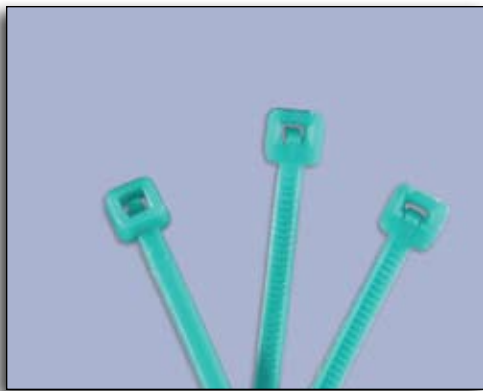

Features and Benefits:

- Fast and easy assembly
- Indoor and outdoor use
- UV (ultraviolet) light resistance
- Flame retardant per UL94 V-0
- RoHS compliant
- Operating temperature range:
-40°F to 302°F (-40°C to 150°C)
- Chemical resistant
- Radiation resistant
- Color: Teal

Applications:

- Cell towers
- Aerial support
- Telecommunications
- Transportation
- General industrial

Stainless Steel Cable Ties Ordering Options

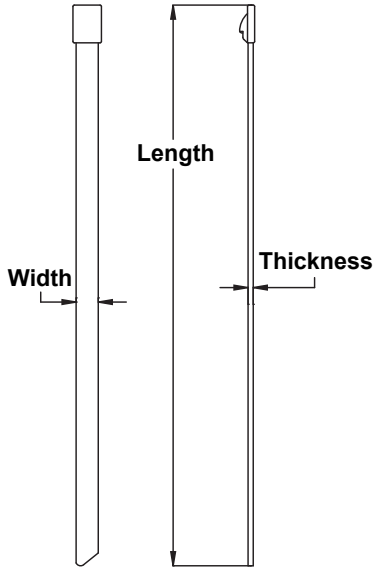

DTi P/N	Length inch (mm)	Width inch (mm)	Thickness inch (mm)	Tie Tensile lb.	Bundle Diameter inch
0501-SS-08-100	7.87 (200.0)	0.181 (4.6)	0.010 (0.26)	100	1.97
0501-SS-14-100	14.17 (360.0)	0.181 (4.6)	0.010 (0.26)	100	3.94
0501-SS-08-250	7.87 (200.0)	0.311 (7.9)	0.010 (0.26)	250	1.97
0501-SS-14-250	14.17 (360.0)	0.311 (7.9)	0.010 (0.26)	250	3.94

Tolerance: ±0.03" (0.76mm)
Packaging: Sealed poly bag in quantities of 100, 1000

Tefzel Cable Ties Ordering Options

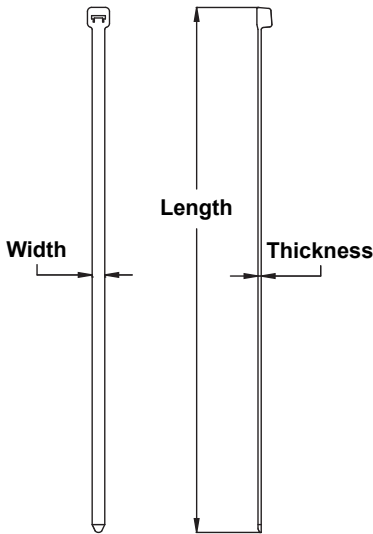

DTi P/N	Length inch (mm)	Width inch (mm)	Thickness inch (mm)	Tie Tensile	Bundle Diameter inch	Max Temp.
0565-050TZ-070C	7.0 (177.8)	0.178 (4.52)	0.053 (1.35)	50 lb.	1.875	302°F
0565-012TZ-040C	4.0 (101.6)	0.094 (2.39)	0.042 (1.07)	12 lb.	0.875	302°F

Tolerances: ±0.03" (0.76mm)
Packaging: Sealed poly bag in quantities of 100, 1000, or customer specified up to 1000 pieces.

Do your fiber optics need rounding up? Sharp corners may be fun on the racetrack, but they can wreak havoc on your fiber optic cables, causing lost data and reduced efficiency.

Fast-Drop Fiber Bend Radius Control Modules provide the BICSI recommended minimum bend radius for fiber optic cables, assuring consistent data transmission. The Fast-Drop is molded of UL94 V-0 flame retardant, impact resistant polycarbonate and is rigid enough to withstand large bundle loads. NEBS compliant.

The universal Fast-Drop quickly snaps on to any panel edge up to 0.104" (2.7mm), retained by a RoHS compliant plated steel slip. It also may be screw or tab mounted to the cabinet to make service loops. Cables are easily contained with the use of our hook and loop strap. Available from stock in three containment widths: 1" (2.5cm), 1.75" (4.4cm), and 3" (7.6cm), in black or beige. Slotted side design allows for easy screw and/or stacking attachment

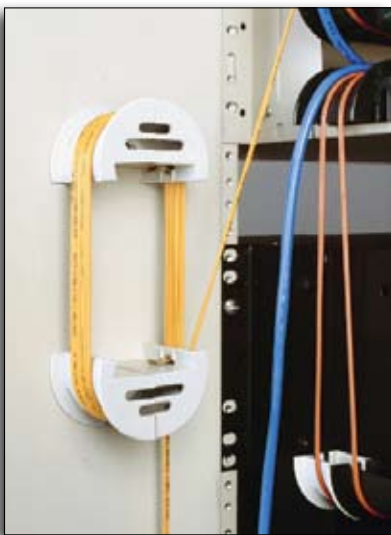

Service Loop/Take-up Reel



Patch Panel Egress

Features and Benefits:

- Fast assembly without adhesives
- Contain and manage cables
- Protects cables from kinks
- Service loops mounting
- Fits within standard unit racks
- Snaps into place
- Impact resistant
- Hook and loop strap containment option
- Flame retardant per UL94 V-0
- RoHS compliant
- Three sizes, two colors
- Available from stock

Applications:

- FTTH or FTTP cabling
- Patch panels, control boxes, racks, cabinets, and enclosures
- Data centers/central offices
- Telecom switches and base stations
- Medical, x-ray, and imaging equipment
- Industrial equipment

Uses:

- Fiber and copper cables
- Electrical wiring
- Pneumatic and fluid tubing
- Hydraulic hoses

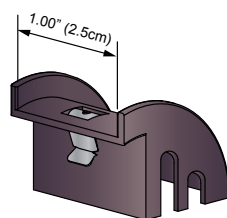

321-1

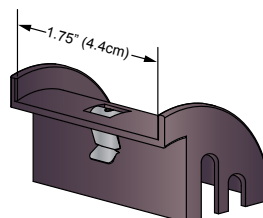

321-2

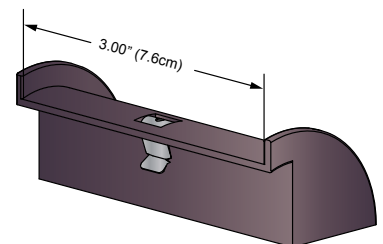

321-3

Fast-Drop Specifications and Ordering Options

Specifications:

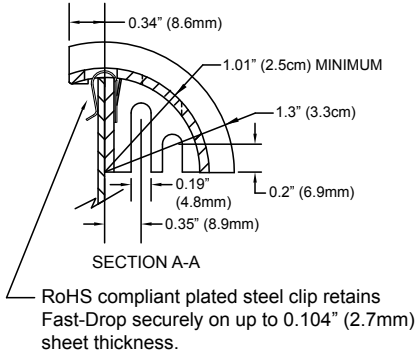
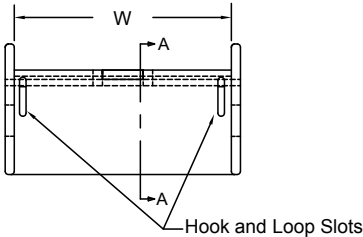

- Material:** Polycarbonate
- Flammability:** UL94 V-0
- Color:** Black or Beige
- Typical Wall Thickness:** 0.090" (2.3mm)

Mounting Options:

Side Screw Mounting

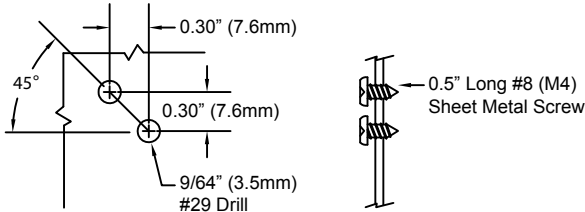

Drill one hole per drill pattern above. Insert first screw and mount Fast-Drop. Use Open slot to spot and drill the second hole and insert second screw.

Vertical Tab Mounting

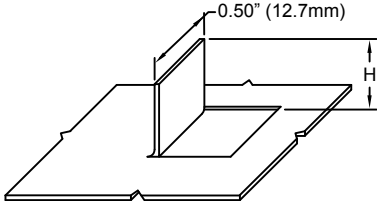

P/N	H
321-1	0.94" (2.4mm)
321-2	1.34" (3.4mm)
321-3	1.94" (4.9mm)

Optional: Include slot tab to lock clip in place.

Part Numbers and Sizes:

Part #	Color	W Max Bundle Width		Overall Width	
		Inches	cm	Inches	cm
321-1A	Black	1.00	2.5	1.18	2.96
321-1B	Beige				
321-2A	Black	1.75	4.4	1.93	4.86
321-2B	Beige				
321-3A*	Black	3.00	7.6	3.18	8.06
321-3B*	Beige				

For Hook and Loop Straps add -HL to part number suffix (i.e. 321-1A-HL)

*3.00" Fast-Drop has no screw mounting slots

Protect-Fast™ AERO and TELCOM

Braided Sleeving

Protect-Fast Braided Sleeving is an efficient solution allowing for easy installation of wires or bundles of cable. It is a tough, lightweight method used to contain and protect cable assemblies, hoses and wire harnesses from abrasion and cutting.



- The PFR material is MIL-202 and FAR25 approved, gasoline resistant, and has a temperature rating from -75°C to 125°C (-103°F to 257°F)
- The ECM material is FAR25 approved with low outgassing, resistant to strong acids and gasoline, and has a temperature rating from -75°C to 150°C (-103°F to 302°F)
- The PFW material is UL94 V-0 and UL VW-1 approved, solvent resistant, and has a temperature rating from -75°C to 125°C (-103°F to 257°F)
- The PSM material is FAR 25 approved, chemical resistant, and has a temperature rating from -70°C to 200°C (-94°F to 392°F)



Features and Benefits:

Feature	PFR	ECM	PFW	PSM
Usage	Aero	Aero	Aero/Telcom	Telcom
Material	Polyethylene Terephthalate Monofilament	ECTFE Copolymer Monofilament	Polyethylene Terephthalate Monofilament	Polyphenylene Sulphide
Monofilament Diameter	0.010"	0.011"	0.008" - 0.015"	0.008"
Wall Thickness	0.025"	0.028"	Variable	0.02"
Flammability Rating	UL VW-1	UL VW-1	UL94 V-0 ULVW-1	-
Industry Standard Approvals	Mil-202 FAR 25 FMVSS 302 FR-1	UL 2024 Plenum NFPA 262 Plenum FAR 25 FMVSS 302	FAR 25	FAR 25
Expansion	150% Sleeve	150% Sleeve	25% Overlap Wrap	150% Sleeve
Operating Temperature Range	-75°C to 125°C (-103°F to 257°F)	-75°C to 150°C (-103°F to 302°F)	-75°C to 125°C (-103°F to 257°F)	-70°C to 200°C (-94°F to 392°F)
Melt Temperature	250°C (482°F)	250°C (482°F)	250°C (482°F)	285°C (545°F)
Corrosion Resistance	Gasoline Engine Chemicals	Strong acids Chlorine Aqueous caustics Gasoline Engine Chemicals	Solvents Chemicals	High Chemical Resistance All solvents below 200°C (392°F)
Abrasion Resistance	High	Medium	Medium	Medium
Recommended Cutting	Hot Knife			
Outgassing	Medium	Low	Medium	Low
Available Colors	White w/ Black Tracer Black w/ White Tracer	White w/ Black Tracer Black w/ White Tracer	Black w/ White Tracer Military Green	Black Natural

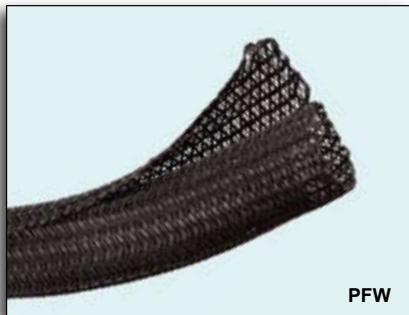

AERO and TELCOM Protect-Fast™ Braided Sleeving

Protect-Fast AERO and TELCOM Product Options

Protect-Fast PFR Braided Sleeving

DTi Part No.	Nominal Size*	Expansion Range	Bulk Roll Sizes	Mini Roll Sizes	Available Colors
PFA-PFR-1	1/4"	1/8" - 7/16"	1000'	200'	Black w/ White Tracer
PFA-PFR-3	1/2"	1/4" - 3/4"	500'	100'	
PFA-PFR-4	3/4"	1/2" - 1 1/4"	250'	75'	
PFA-PFR-6	1 1/4"	3/4" - 1 3/4"	250'	50'	White w/ Black Tracer
PFA-PFR-7	1 1/2"	1" - 2 1/2"	200'	40'	
PFA-PFR-9	2"	1 1/2" - 3 1/2"	200'	50'	

Order Examples

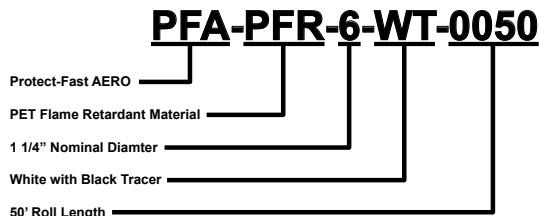

Protect-Fast ECM Braided Sleeving

DTi Part No.	Nominal Size*	Expansion Range	Bulk Roll Sizes	Mini Roll Sizes	Available Colors
PFA-ECM-1	1/4"	1/8" - 7/16"	1000'	200'	Black w/ White Tracer
PFA-ECM-2	3/8"	3/16" - 5/8"	500'	125'	
PFA-ECM-3	1/2"	1/4" - 3/4"	500'	100'	
PFA-ECM-4	3/4"	1/2" - 1 1/4"	250'	75'	White w/ Black Tracer
PFA-ECM-6	1 1/4"	3/4" - 1 3/4"	250'	50'	
PFA-ECM-9	2"	1 1/2" - 3 1/2"	250'	50'	

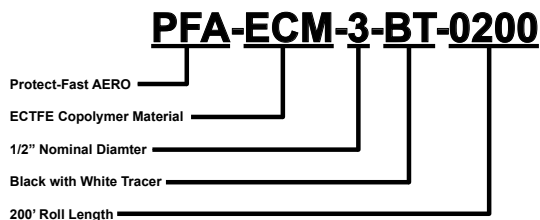

Protect-Fast PFW Braided Wrap

DTi Part No.	Nominal Size	Expansion Range	Bulk Roll Sizes	Mini Roll Sizes	Available Colors
PFA-PFW-0	1/8"	-	400'	100'	Black with White Tracer Military Green
PFA-PFW-1	1/4"	-	200'	100'	
PFA-PFW-3	1/2"	-	150'	75'	
PFA-PFW-4	3/4"	-	100'	50'	
PFA-PFW-5	1"	-	100'	50'	
PFA-PFW-7	1 1/2"	-	75'	25'	
PFA-PFW-9	2"	-	50'	25'	

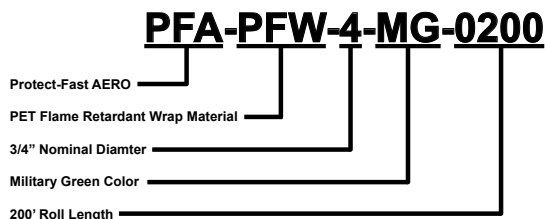

*Other sizes available for ECM, PSW, and PFR material

Protect-Fast PSM Braided Sleeving

DTi Part No.	Nominal Size	Expansion Range	Bulk Roll Sizes	Mini Roll Sizes	Available Colors
PFT-PSM-0	1/8"	3/32" - 1/4"	1000'	225'	Black Natural
PFT-PSM-1	1/4"	1/8" - 7/16"	1000'	200'	
PFT-PSM-3	1/2"	1/4" - 3/4"	500'	100'	
PFT-PSM-4	3/4"	1/2" - 1 1/4"	250'	75'	
PFT-PSM-6	1 1/4"	3/4" - 1 3/4"	250'	50'	
PFT-PSM-8	1 3/4"	1 1/4" - 2 3/4"	200'	30'	
PFT-PSM-9	2"	1 1/2" - 4"	200'	30'	

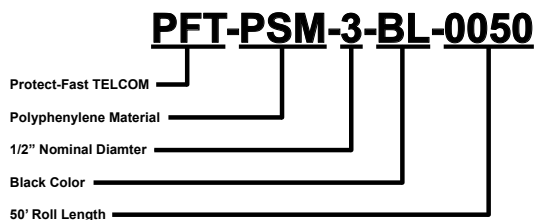

PF Braided Sleeving Installation Tool

DTi Part No.	PF14	PF12	PF34	PF1	PF112
Sleeve Size	1/4"	1/2"	3/4"	1"	1 1/2"

Protect-Fast™ Industrial

Braided Expander & Shield Expander

DTi's Protect-Fast Expander and Shield Expander products provide excellent flexibility and abrasion resistance for wire and cable organizing within a variety of applications including telecommunications, automotive, electronics, and data center design. It's open woven structure enables the Expander to be enlarged up to 3 times the initial diameter. The Shield Expander has the same mechanical properties as the Expander but also provides excellent shielding effectiveness because of it's woven fibers and conductive copper wire design.

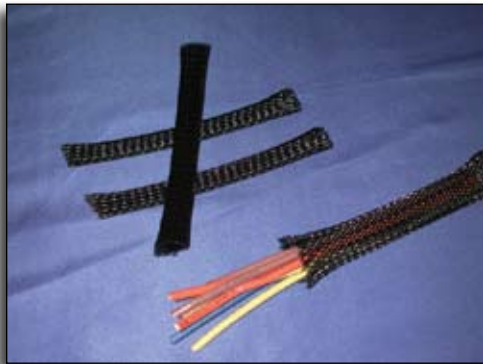

Features and Benefits:

- Superior flexibility
- Excellent abrasion resistance
- Colors: Black, White, Blue, Red, and Black and White Stripe
- Flammability: UL94-V0
- Excellent surface resistivity: Shield Expander only

Applications:

- Telecommunication
- Transportation
- Theaters
- Data Centers

Expander and Shield Expander Specifications:

Content	Expander	Shield Expander
Material	PET monofilament	Sn plated flat Cu wire around glass fibers
Service Temp. (°C)	-65 ~ 125	-70 ~ 125
Density (g/cm ³)	1.40	-
Tensile Strength (kgf/cm ²) [ksi]	645.7 [9.2]	-
Elongation (%)	20	-
Melting Point (°C)	255	-
Surface Resistivity (Ω/sq.)	-	0.02
Flammability	UL94 V-0	Non-Flammable

Protect-Fast Industrial Part Numbers:

	Part Number	Size Inches	Inner Diameter Range Inches	Reel Length	
				feet	mm
Flame Retardant Expander	N0XXFR-1000	1/4	1/8 - 1/2	3280	1000
	N1XXFR-0300	1/4	1/8 - 3/8	984	300
	N2XXFR-0300	3/8	3/16 - 1/2	984	300
	N3XXFR-0300	1/2	1/4 - 3/4	984	300
	N4XXFR-0150	3/4	1/2 - 1 1/4	492	150
	N5XXFR-0100	1 1/4	3/4 - 1 1/2	328	100
	N6XXFR-0100	1 1/2	1 1/4 - 2 1/4	328	100
Shield Expander	C0NF-0300	1/4	1/8 - 1/2	984	300
	C1NF-0300	1/4	1/8 - 3/8	984	300
	C2NF-0200	3/8	3/16 - 1/2	656	200
	C3NF-0200	1/2	1/4 - 3/4	656	200
	C4NF-0100	3/4	1/2 - 1 1/4	328	100
	C5NF-0100	1 1/4	3/4 - 1 1/2	328	100

Expander Color Options:

XX Color Codes	Colors
BK	Black
WH	White
BW	Black/White Line
RD	Red
BU	Blue

Ordering Examples:

N4WHFR-0150

Type: Non-Flammable Expander

Size: 3/4"

Range: 1/2" ~ 1 1/4"

Color: White

Length: 492' (150m)

C2NF-0200

Type: Shield Expander

Size: 3/8"

Range: 3/16" ~ 1/2"

Color: Silver

Length: 656' (200m)

The Hook and Loop cable management strap is a self gripping fastener that offers a neat and secure way to bundle cables and cords. The Hook and Loop Strap wraps around cables and latches on its opposing side for secure containment. The Hook and Loop Strap is made from UL94 flammability rated material.



Features and Benefits:

- RoHS compliant
- Flame retardant per UL94 V-2
- Burn resistant per MVSS 302
- Fire and smoke resistant per FAR 25.853F, part (a), (l), (i) vertical 60 second burn and (ii) 12 second burn
- Acceptance per NEC 300-22, paragraph (c) and (d)
- Load capacity: 18lbs
- Contact area: 0.73in² (4.84cm²)

Applications:

- Automotive
- Cable management
- Fiber management
- Data center installations
- Gaming equipment
- Aircraft
- Air handling equipment
- Telecommunications
- Medical equipment
- Appliances

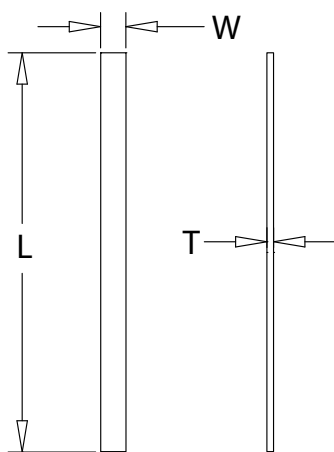

Part Number	W Width inches (mm)	T Thickness inches (mm)	L Length inches (mm)	Pieces per reel
321L4.5	0.38 (9.6)	0.1 (2.54)	4.5 (114.3)	1600
321L6.0	0.38 (9.6)	0.1 (2.54)	6.0 (152.0)	1200
321L9.0	0.38 (9.6)	0.1 (2.54)	9.0 (228.6)	800

Packaging: Perforated lengths on reels of 600 ft. Custom sizes available
Material: Polypropylene hook laminated to a nylon loop
Color: Black



DTi offers a variety of cable tie tools for tensioning, removal, or wire stripping. The tension and cutoff tools quickly apply tension and cut off excess cable tie material without leaving sharp edges while also eliminate snags, cuts, and abrasions on cables.

The cable tie removal tool provides maximize natural hand contraction motion, assisted with an auto return spring. Works with all plastic cable tie strap widths or lacing cords and 12 to 22 solid and stranded gauge wire

Cable Tie Tension Tools

8100TT: The most cost effective. Quickly applies tension and cuts excess cable tie material with a twist of the tool.



8200TT: Automatically cuts off excess cable tie material or selected tension setting. Produces consistent tension from tie to tie with one easy pull of the trigger.

8300TT: Designed for larger cable ties with tensile strength greater than 50lbs and cuts off cable tie material with one squeeze of the handle.

8900TT: Stainless steel tool quickly applies tension and cuts off excess cable tie material automatically when setting is achieved with no sharp metal protrusions.

Cable Tie Removal Tools

8100RT: The cable tie removal tool provides maximize natural hand contraction motion, assisted with an auto return spring. Features a safety tip to remove cable tie without cutting into bundled wires.

8200RT: Includes the same features as the 8100RT with the added ability to strip 12-22 gauge wire.



EMI/RFI Shielding

G Series
Fabric over Foam Gaskets



FS Series
Conductive Foam Cushion Gasket

ST, DT, and MT Series
Single and Double Sided Conductive Tapes



FA Series
RF Absorber Material

S Series
Stamped Finger Gaskets

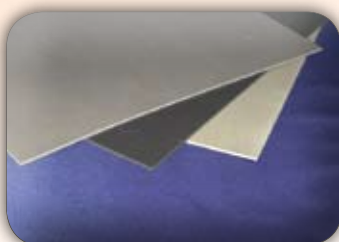
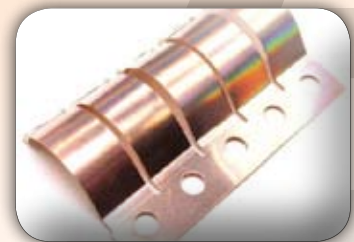

DTIM Series
Thermal Interface Material

Device Technologies' Ground-Fast grounding system quickly attaches a lid or cover to a panel, protecting printed circuit boards and electronics components. The fastener combines mounting clips, which quickly snaps into holes to create an electrical ground contact from the lid to the panel.

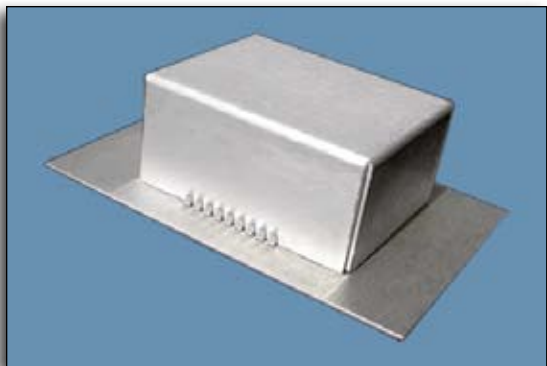

Features and Benefits:

- Flush surface mounting
- Fast snap-in or solder attachment
- Fast removal of lid from panel
- High closure force
- High tensile strength

Electrical Resistivity:

- 28.4μΩ-in. @ 68°F (72μΩ-cm @ 20°C)

Material:

- Stainless Steel

Part Number: 07115-1

Mounting Dimensions:

- Clip hole diameter: 0.180in. (4.0mm)
- Panel thickness: 0.060in. (1.52mm)

Mounting

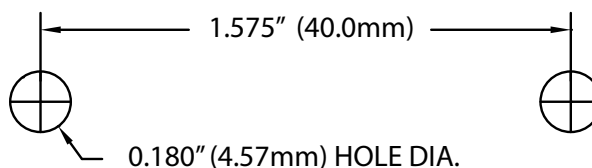

Dimensions

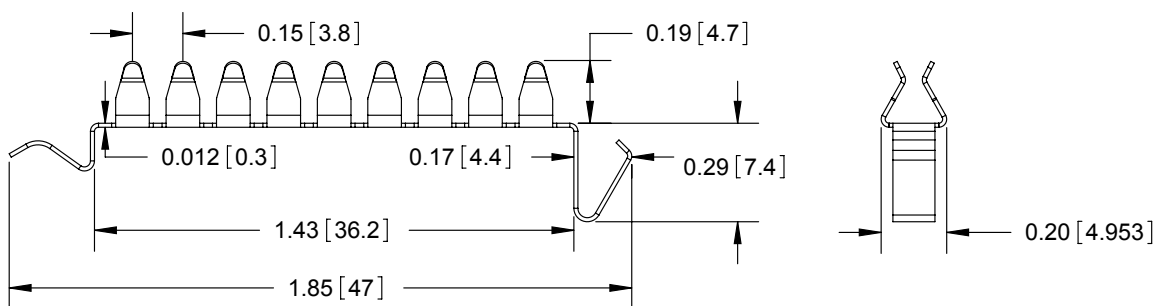

Universal and Continuous Grounding Panel Fastener

Device Technologies' Ground-Fast grounding system quickly attaches a lid or cover to a panel, protecting printed circuit boards and electronics components. The fastener combines mounting clips, which quickly snaps into holes to create an electrical ground contact from the lid to the panel.

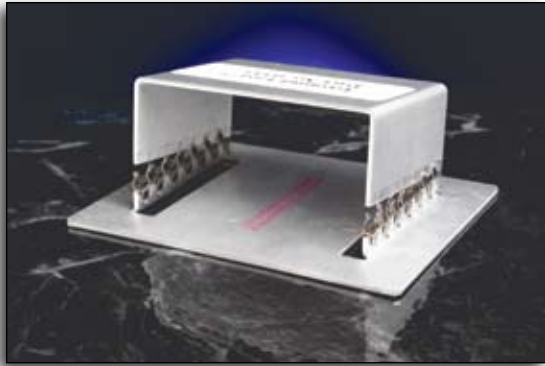

Features and Benefits:

- Flush surface mounting
- Fast snap-in or solder attachment
- Fast removal of lid from panel
- High closure force
- High tensile strength

Electrical Resistivity:

- 28.4μΩ-in. @ 68°F (72μΩ-cm @ 20°C)

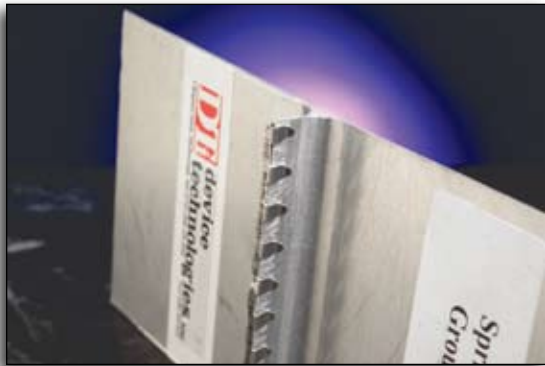

Material:

- Stainless Steel

Part Numbers:

Product Number	Product Size	G Gap Inches
07115-2 07115-3 07115-4	0	0.010 - 0.015
	1	0.015 - 0.020
	2	0.025 - 0.030
	3	0.046 - 0.051

Universal Style

07115-2

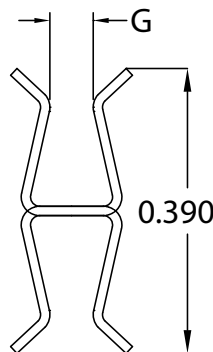

07115-3

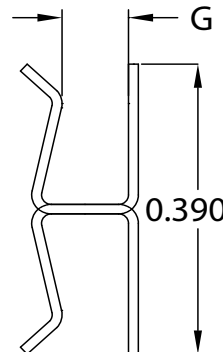

Continuous Style

07115-4

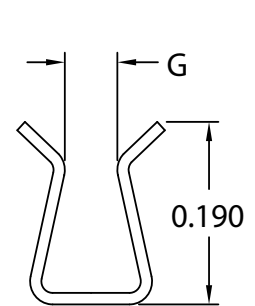

EMI/RFI Shielding

G Series Fabric Over Foam

DTi offers the G Series Conductive Fabric Over Foam Gaskets for a wide variety of EMI shielding applications. The G Series consists of a conductive fabric on a highly compressed polyurethane foam core with a conductive adhesive tape. Excellent flexibility with superior adhesive strength guarantee a precise fit on uneven surfaces.

DTi's G Series also offers a gold fabric option, providing increased conductivity and minimum oxidation over the nickel or silver fabrics.

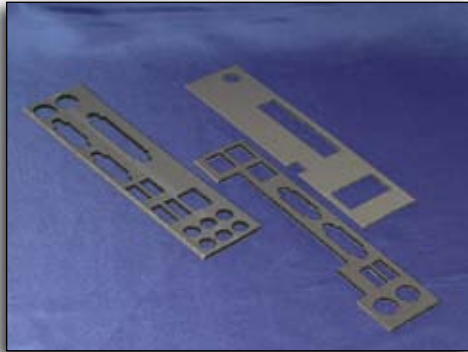

Backplane I/O

Features and Benefits:

- UL94 V-0 flammability rating
- RoHS compliant
- Excellent flexibility
- Superior adhesive tape
- Easy to cut and install
- Available in customer specified width & height
- Std. length - 1 meter or cut to length

Applications:

- Mobile phones
- Backplanes
- Navigation systems
- Entertainment systems
- Satellite radio receivers
- Telecommunication systems
- I/O panel connector



Mobile phone

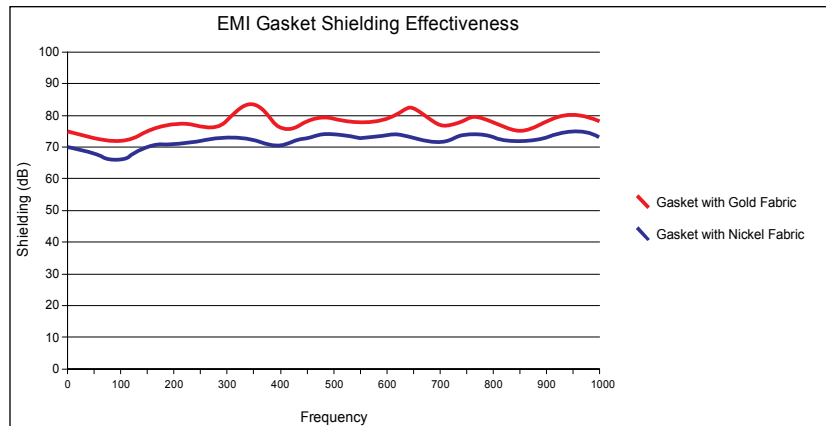

Various profile options

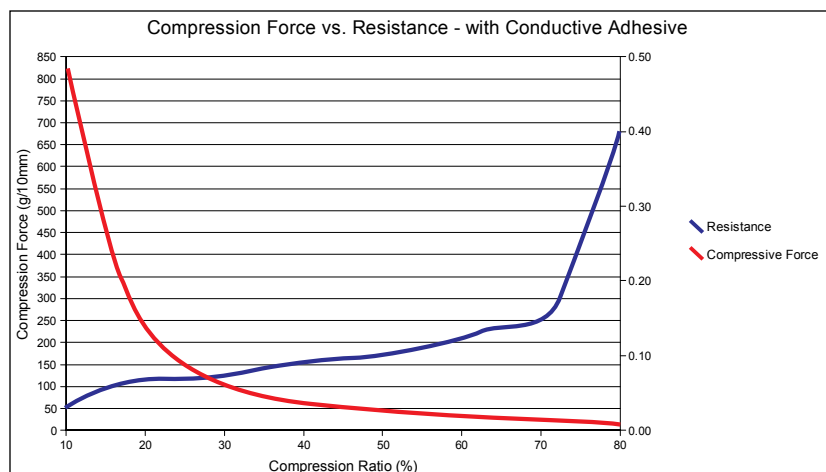

G Series Fabric Over Foam Ordering Options

Shape Options:

RR - Round

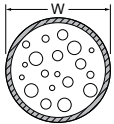

R - Rectangle

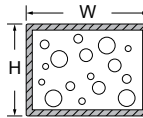

DS - D Shape

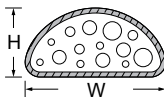

DD - Double D Shape

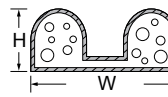

FL - Folding Leaf

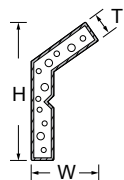

FR - Flat Rectangle

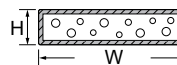

IO - Wide I/O

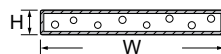

PS - P Shape

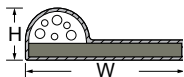

KE - Knife Edge

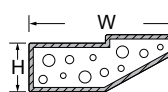

LS - L Shape

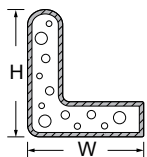

CF - C Fold

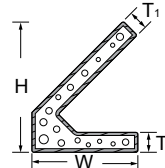

Ordering Example:

G-45QGFZ-3.0-0.8-1.8-AFZC1.0-R

(1) (2) (3)(4) (5) (6) (7) (8) (9)(10) (11)

- (1) - G Series Fabric Over Foam
- (2) - 45kg/m³ Brown Halogen-Free Polyurethane Foam
- (3) - Gold Fabric
- (4) - Halogen-Free, Flame Retardant Hotmelt
- (5) - Width: 3.0mm
- (6) - Height: 0.8mm
- (7) - Length: 1.8mm
- (8) - Adhesive: Halogen Free, Flame Retardant Aluminum Foil Tape
- (9) - Adhesive Position: Center
- (10) - Adhesive Width: 1.0mm
- (11) - Shape: Rectangle

Sponge Options:

Sponge Part Number	Sponge Type
45B	45kg/m ³ PU Foam (Black)
32B	32kg/m ³ PU Foam (Black)
45Q	45kg/m ³ Halogen Free PU Foam (Brown)
32Q	32kg/m ³ Halogen Free PU Foam (Brown)

Fabric Options:

Fabric Part Number	Fabric Type
GF	Gold Fabric
NFW	Plain-Woven Nickel Fabric
NFR	Ripstop Nickel Fabric
NFN	Non-Woven Nickel Fabric

Hotmelt Options:

Hotmelt Part Number	Hotmelt Type
H	Standard Hotmelt
F	Flame Retardant Hotmelt
Z	Halogen-Free Flame Retardant Hotmelt

Adhesive Options:

PSA Part Number	PSA Type
23	Conductive Fabric Tape
23Z	Conductive Halogen-Free, Flame Retardant Fabric Tape
A	Conductive Aluminum Tape
AFZ	Conductive Halogen-Free, Flame Retardant Aluminum Tape
N	Without PSA

Position of Adhesive

Position Code	Description
C	Center
B	Both Sides
S	Side
D	Custom

EMI/RFI Shielding

FS Series Conductive Cushion Gasket

Conductive cushion gaskets offer an innovative approach to traditional shielding and grounding by providing X, Y and Z axis conductivity which enhances the shielding effectiveness. This is required to meet the increasing microprocessor speeds of today's computer, telecommunications and aerospace equipment.

DTi's FS Series Conductive Cushion Gaskets have a basic construction of Ni-Cu plated polyolefin (F01) foam, laminated with conductive fabric. Available in roll, sheet, or custom die cut forms.



Mobile phone grounding/shock pad

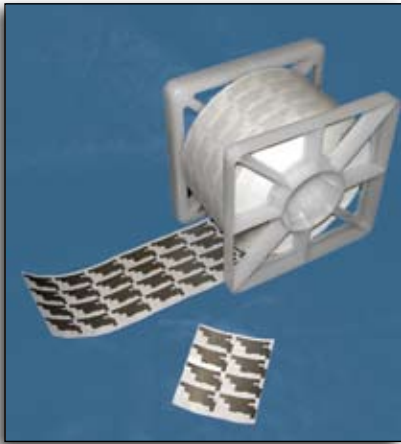

Die cut solution on Roll Caddy



Raw sheet stock (Rolls not pictured)

Features and Benefits:

- Superior shielding effectiveness combined with Shock Absorption
- Excellent conductivity-deflection rate
- Various thicknesses available
- Easy installation with or without conductive PSA
- Wide temperature capability -30°C to 90°C

Applications:

- Wireless device displays and speaker cutouts
- Grounding between PCB and chassis
- PCI bracket
- Medical equipment
- Telecommunication equipment
- Automotive
- Appliances
- Computer and Servers

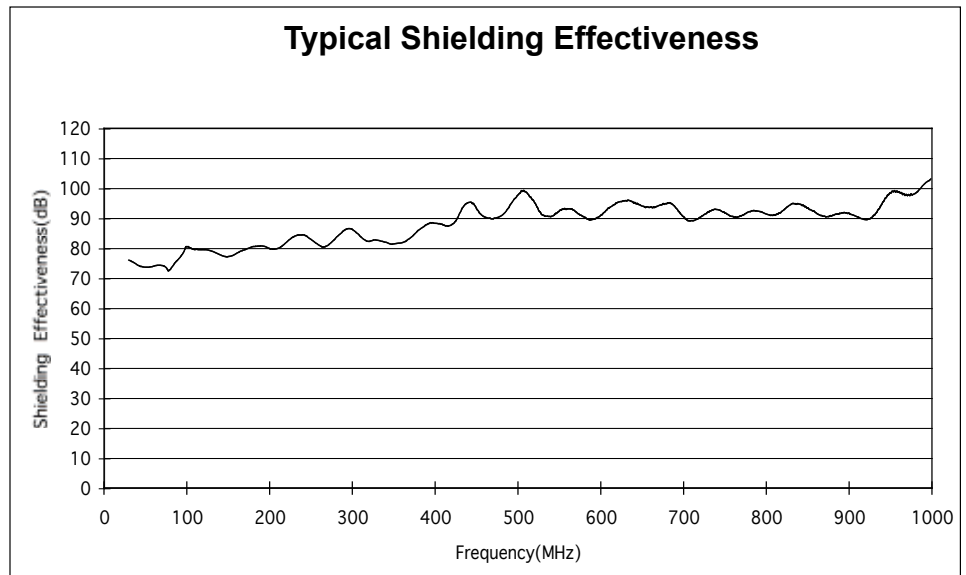

EMI/RFI Shielding FS Series Conductive Cushion Gasket

FS Series Specifications and Ordering Options

Conductive Fabric Material

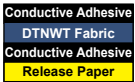
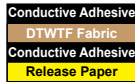
Specification	FS12C	FS12C23
Foam Type	F01	23F01
Foam Description	Conductive Polyolefin Fabric Foam with Ni-Cu-Ni and high strength modified conductive tape	Conductive Polyolefin Fabric Foam with Ni-Cu-Ni and high strength modified conductive tape
Tape Type	Non-Woven Nickel Fabric Tape 	Woven Nickel Fabric Tape 
Contact Resistivity (Ω /sq.)	Max 0.1	
Shielding Effectiveness (dB)	Min. 60	
Adhesive Strength (gf/25mm)	Min. 1000	
Thickness Options mm (inches)	0.2 (0.008) ~ 1.5 (0.059)	0.2 (0.008) ~ 1.5 (0.059)

Specification: Foam and Tape Structure

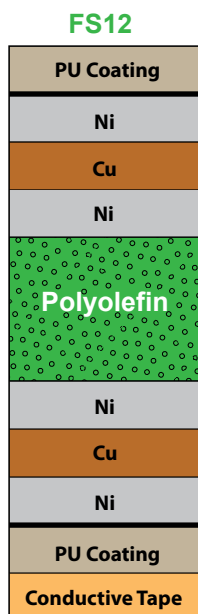

Ordering Examples

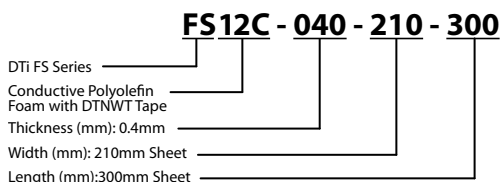
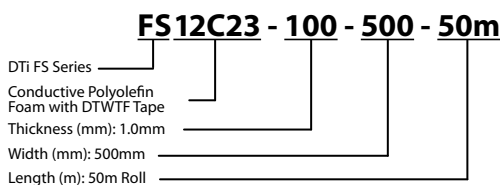

Conductive Foam Properties

Property	Polyolefin Foam
Density	28.1 lb/ft ³ (450 kg/m ³)
Tensile Strength	583 psi (40.0 kgf/cm ²)
Elongation	≥31%
Compression Set	≤50%
Flammability	None

Also available with non-conductive adhesive tape

Part numbers:
FS12N, FS12N23

Packaging Options:

- Sheets - 210mm x 300mm
- Custom Die Cut
- Rolls

RFI Shielding - RF Absorber Materials

FA Series

DTi offers the FA Series RF Absorber Materials for the suppression of electromagnetic waves in electronic devices. The FA Series covers a wide frequency range (10MHz ~ 18GHz) to provide excellent suppression of high frequency radiated noise, conduction noise, and electrical surge. The FA Series RF Absorber Material accomplishes this by absorbing electromagnetic waves into heat and suppresses reflected waves. The material is thin, lightweight, and flexible and can be applied to a variety of applications with the adhesive tape. The FA Series is available in sheet or roll form but can be die cut to custom shapes and sizes.



Sheet stock

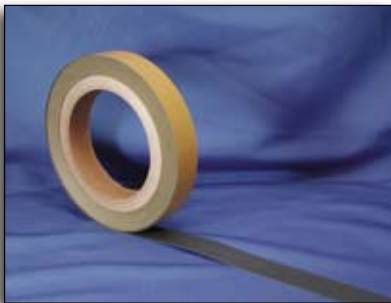

Roll Stock



Digital camera LCD screen application

Features and Benefits:

- Wide frequency range: 10MHz to 18GHz
- Thin, lightweight, and flexible
- High electrical resistance
- Excellent internal interference suppression
- Easily die cut to custom specifications

Applications:

- Personal computers
- Mobile phones
- LCD cables
- Military equipment
- Consumer electronics
- Appliances
- Laboratory instrumentation
- Telecommunications

Typical Absorption and Shielding Performance:

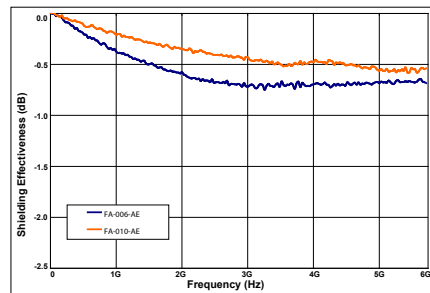

Typical Absorption in A Type Construction

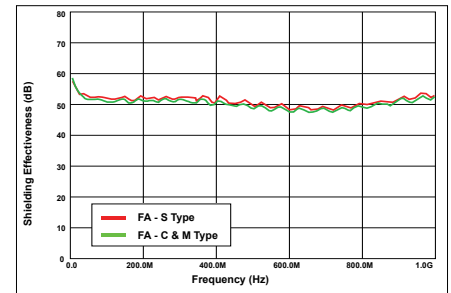

Typical SE in S, C, & M Type Construction

Concepts of Absorption and Shielding:

FA Series Absorber Material

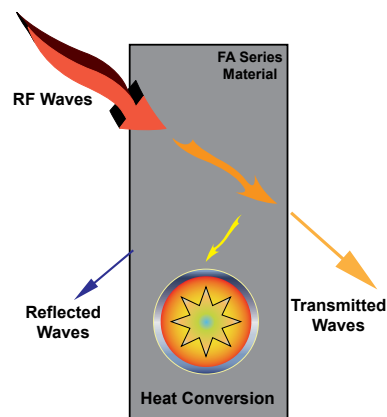

Shielding Material

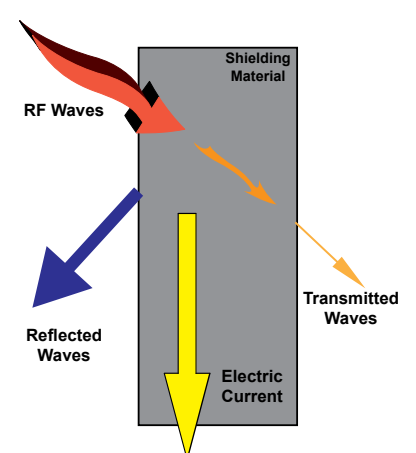

FA Series Specifications and Options

	C Type		M Type		A Type		S Type
Thickness (mm)	0.11	0.15	0.11	0.15	0.08	0.12	0.05
Adhesive Tape	A Type: 0.10mm A1 Type: 0.05mm				A2 Type: 0.03mm A3 Type: 0.02mm		
Frequency Range	10MHz ~ 18 GHz						
Service Temp °C (°F)	-20° ~ 120° (-4° ~ 248°)						
Shielding Effectiveness dB (30MHz ~ 1GHz)	Min. 40				-		Min. 40
Surface Resistance Ω	Min. 1.0x10 ¹² (Insulator)						
Standard Sizes	210mm x 20m (Roll) 210mm x 300mm (Sheet)						

Tape Layer Structure

M-Type

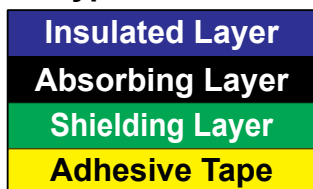

C-Type

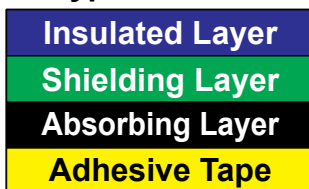

S-Type



A-Type



Ordering Examples

FA-011-CI-210-300-A

FA Series
 Thickness: 0.11mm
 Structure: C-Type insulated
 Width: 210mm
 Length: 300mm sheet
 Adhesive Tape: A Type, 0.10mm thick

FA-015-MI-210-20M-A1

FA Series
 Thickness: 0.15mm
 Structure: M-Type insulated
 Width: 210mm
 Length: 20m roll
 Adhesive Tape: A1 Type, 0.05mm thick

Absorber-only sheets available. Please Customer Service for information and samples.

Thermal Interface Materials

DTIM Series

The performance of electronic devices is constantly improving but with this evolution comes greater power consumption and heat generation. If heat cannot escape efficiently, the performance of the device suffers. To transfer heat effectively, the introduction of DTIM Thermal Interface Materials becomes necessary. DTIM material properties combine high thermal conductivity, flame-retardant properties for heat resistance, and electrical insulation. These requirements are becoming very important qualifications in the electronics industry.

Silicone based thermal interface materials contain a high ratio of thermally conductive ceramic fillers. They exhibit outstanding thermal conductivity because they conform well in the gap between the heat generating device and the heat-sink.

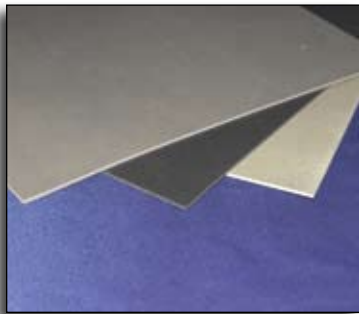
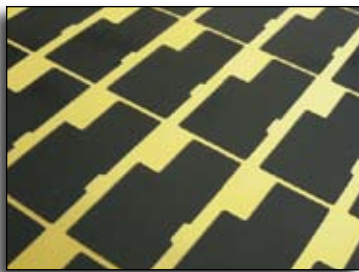

Features and Benefits:

- UL94 V-0 flammability rated
- Highly compressible
- Low thermal impedance
- Inherently sticky, but optional adhesive tape available
- Stable from -30°C to 200°C

Applications:

- Micro Processors
- Memory Chips
- RDRAM Modules
- High Speed Storage Devices
- Telecommunications Hardware
- Automotive Engine Control Units
- Cooling Components to the chassis or frame

How DTIM thermal interface materials work:

DTIM G0, G1, & G2 Gels and Sheet:

Without DTIM material contact between two surfaces can contain up to 90 percent air filled voids which resists heat transfer.

Without DTIM material

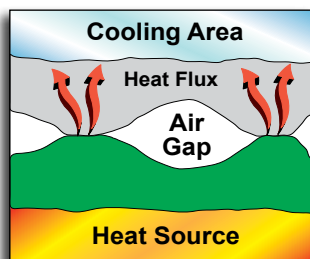

Adding DTIM G0, G1, or G2 material closes air filled voids and allows for greater heat transfer.

With DTIM material

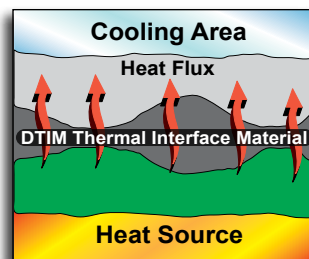

DTIM G3 Sheet:

DTIM G3 material intercepts vertical heat transfer and spreads heat horizontally.

With DTIM G3 material

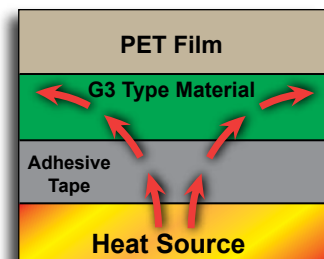

DTIM Thermal Interface Material Specifications and Ordering Options

G0, G1, & G2

Characteristic	DTIM G0 Type	DTIM G1 Type	DTIM G2 Type
Type	Sheet	Gel	
Thickness (mm)	0.1 ~ 0.35	0.5 ~ 10.0	0.2 ~ 10.0
Durometer	60 (Shore A)	< 40 (Shore OO)	60 (Shore OO)
Color	White	Gray	
Volume Resistivity ($\Omega \cdot \text{cm}$)	1.0×10^{11}		
Voltage Breakdown (kV)	5.1	> 6	5.1
Thermal Conductivity (W/mk)	Min. 4.0	Min. 2.0	Min. 1.5
Temperature Range	-30°C ~ 200°C (-22°F ~ 392°F)		
Flammability Rating	UL94 V-0		

G3

Characteristic	DTIM G3 Type
Type	In-Plane Sheet
Standard Sizes	Roll (500mm x 25m)
	Sheet (210mm x 300mm)
Thickness (mm)	0.13 ± 0.02
	0.16 ± 0.02
	0.18 ± 0.03
Color	Black
Vertical Thermal Conductivity (W/mk)	Max 0.5
Horizontal Thermal Conductivity (W/mk)	Max 8.0
Resistivity ($\Omega \cdot \text{cm}$)	Non-Conductive
Service Temperature	-10°C ~ 120°C (14°F ~ 248°F)
Flammability Rating	UL94 V-0

G3 Layers

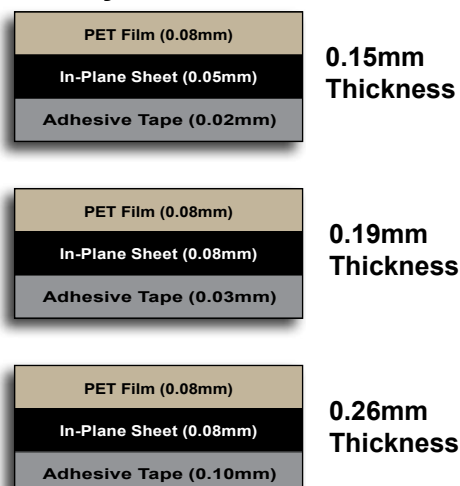

How to Apply

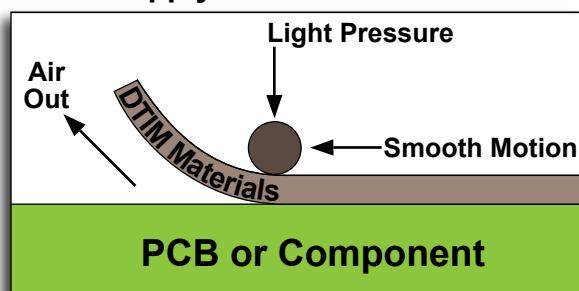

Ordering Options

DTIM-TTT-Gx-WWW-LLL-YY-ZZ

Serial No.:	DTIM
TTT:	Thickness (001 is 0.10mm)
Gx:	G series type (G0, G1, G2, G3)
WWW:	Width (100 is 10.0mm)
LLL:	Length (300 is 30.0mm)
YY:	Optional Adhesive Tape - A1 (0.1mm), A2 (0.03mm), A3 (0.01mm), AT (0.05mm Al foil tape), NT (without tape)
ZZ:	Special Options - No Code (standard rectangle), DC (Die Cut - G0 & G3 only), RR (Roll - G3 Only), PR (Pressed - G1 & G2 only), NP (Non Pressed - G1 & G2 only)

EMI/RFI Shielding

ST & DT Series Conductive Fabric Tapes

DTi's Conductive Fabric Tapes are composed of a conductive substrate and adhesive. They offer a thin, lightweight, and flexible shielding design. The ST and DT series' pressure sensitive adhesives (PSA) are produced using highly conductive adhesives either on their own or combined with conductive textiles. The conductive PSA offers superior mechanical, electrical and adhesive properties. ST and DT Fabric Tapes are ideal for sealing seals and wrapping cables for shielding and grounding applications.



Features and Benefits:

- Excellent shielding effectiveness
- Highly flexible
- Lengths of 25 or 50 meters
- Optional flame retardant layer
- Can be die cut to custom shapes

Applications:

- Computer
- Telecommunications
- Military
- General electronics
- Medical equipment
- Automotive

Typical Shielding Effectiveness of DT Series

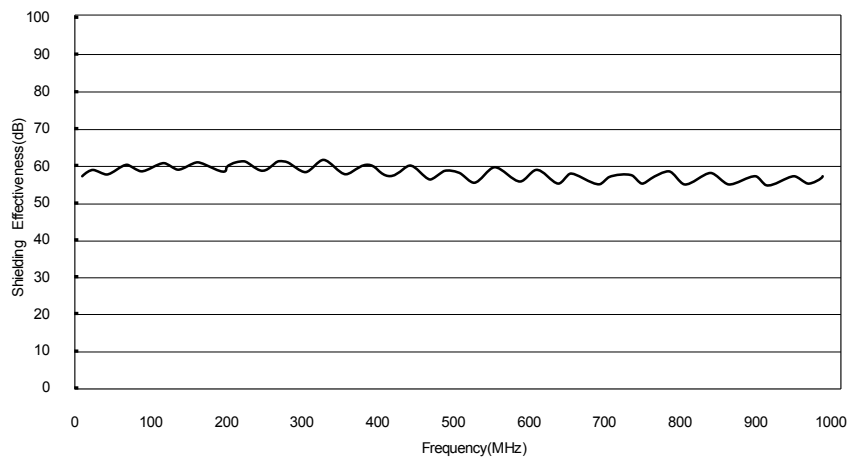

Typical Shielding Effectiveness of ST Series:

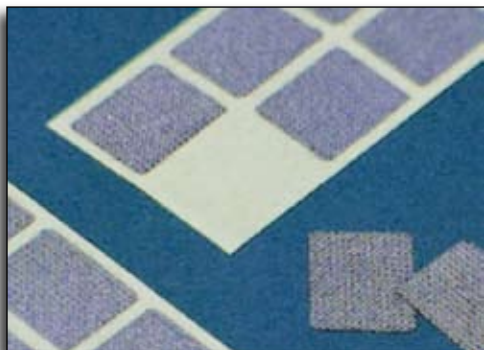
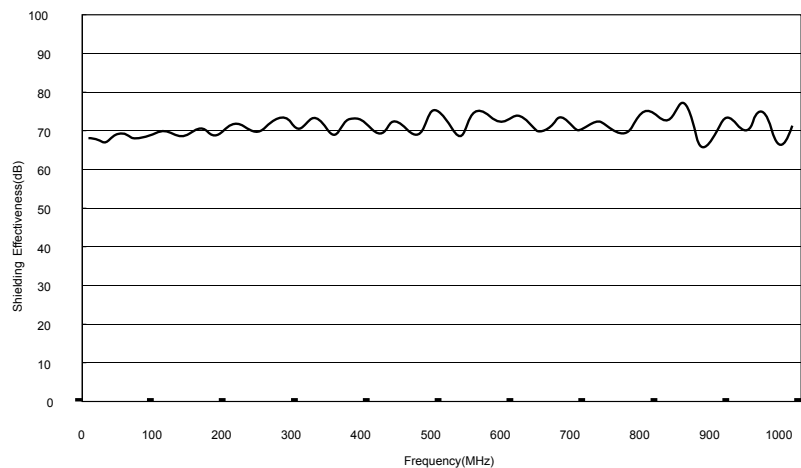

EMI/RFI Shielding

ST & DT Series Conductive Fabric Tapes

Single Sided Tape Specifications

DTi Part Number	Structure	Fabric Type	T Thickness		W Width		L Length		Contact Resistivity (Ω/sq.)	Adhesive Strength (gf/25mm)
			inches	mm	inches	mm	feet	m		
STWMF007	Conductive Fabric Conductive Adhesive Release Paper	Thin Nickel	0.0028	0.07	39.37	1000	164	50	<0.03	>800
STRF012	Conductive Fabric Conductive Adhesive Release Paper	Ripstop Nickel	0.0047	0.12	39.37	1000	164	50	<0.10	>900
STRF012N	Conductive Fabric Non-Conductive Adhesive Release Paper	Ripstop Nickel	0.0047	0.12	39.37	1000	164	50	-	>1000
STWMF013	Conductive Fabric Conductive Adhesive Release Paper	Woven Nickel	0.0051	0.13	39.37	1000	164	50	<0.1	>900
STWMF013N	Conductive Fabric Non-Conductive Adhesive Release Paper	Woven Nickel	0.0051	0.13	39.37	1000	164	50	-	>1000
STRF014	Conductive Fabric Conductive Adhesive Release Paper	Ripstop Nickel	0.0055	0.14	39.37	1000	164	50	<0.2	>850

Double Sided Tape Specifications

DTi Part Number	Structure	Fabric Type	T Thickness		W Width		L Length		Contact Resistivity (Ω/sq.)	Adhesive Strength (gf/25mm)
			inches	mm	inches	mm	feet	m		
DTWMF008	Conductive Adhesive Conductive Fabric Conductive Adhesive Release Paper	Thin Nickel Fabric	0.0031	0.08	19.69	500	164	50	<0.03	>600
DTMES011	Conductive Adhesive Conductive Mesh Conductive Adhesive Release Paper	Conductive Mesh	0.0043	0.11	39.37	1000	164	50	<0.10	>800
DTWTF011	Conductive Adhesive Conductive Fabric Conductive Adhesive Release Paper	Conductive Fabric	0.0043	0.11	39.37	1000	164	50	<0.05	>800
DTRF011	Conductive Adhesive Conductive Fabric Conductive Adhesive Release Paper	Thin Nickel Ripstop Fabric	0.0026	0.065	19.69	500	164	50	<0.03	>600

Additional Material Options

- Thicknesses range from 0.06mm ~ 0.68mm
- Flame retardant layer
- Conductive or Non-Conductive Adhesive
- Multiple layers of fabric
- Polyester film top layer
- Custom width rolls

Ordering Examples

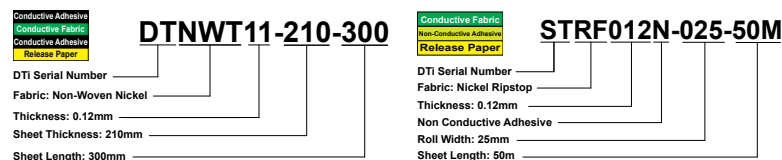

Fabric Types

Fabric Type	Notes
Plain Woven Nickel Fabric	
Ripstop Nickel Fabric	
DTY Nickel Fabric	Draw Thread Yarn Fabric
Non-Woven Nickel Fabric	
Gold Fabric	Gold Coated Nickel Fabric
Low Resistivity Nickel Fabric	≤0.03 Surface Resistivity
Thin Nickel Fabric	0.05mm thickness
Silver Fabric	Silver Coated Nickel Fabric

Custom layer configurations available. Contact Customer Service for information and samples.

EMI/RFI Shielding

SMT & DMT Series Metal Foil Adhesive Tapes

DTi offers an extremely broad range of metal foil based conductive adhesive tapes. The SMT and DMT Series Metal Foil Tapes are produced using highly conductive adhesives either on their own or combined with a variety of metal foils. The SMT and DMT Series adhesive tapes have superior mechanical, electrical, and adhesive properties. These characteristics provide a thin, lightweight, and flexible shielding design.

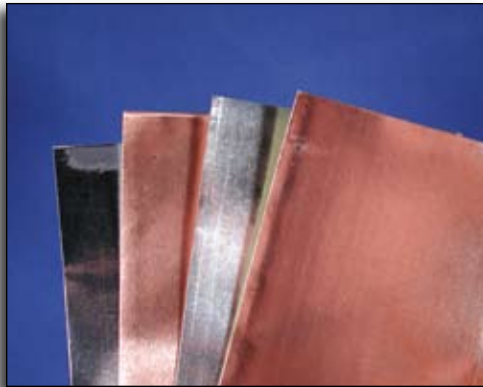

Features and Benefits:

- Highly flexible
- High conductivity
- Excellent shielding effectiveness
- Copper or aluminum foils
- Corrosion resistant
- Single or double sided construction

Applications:

- Wire harnesses
- Grounding
- Sealing seams



Application Techniques:

- Bonding surfaces must be clean and dry. Isopropyl alcohol is recommended as a cleaning agent.
- Bond strength can be increased by applying ST Series PSA firmly with a roller or finger pressure to exclude air entrapment.
- Adhesion is optimized when the substrates are flat or conformable.
- Adhesion increases after application, up to 24 hours later, due to increased wetting by the tape.
- Most metal surfaces give enhanced electrical performance with ST Series PSA by lightly roughing the surface.
- ST Series PSA should be applied between 60°F - 100°F (15°C - 38°C). Tape application below 50°F (10°C) is not recommended.
- Warming the substrates to 100°F (38°C) facilitates adhesion. Once properly applied, low temperature holding power is generally satisfactory.

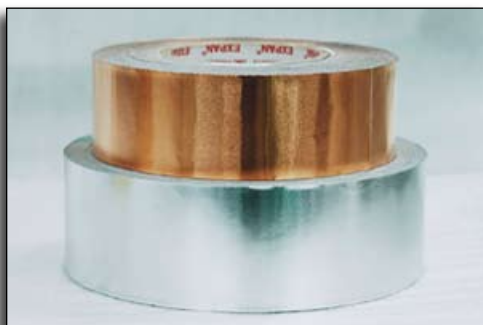

DMT Construction

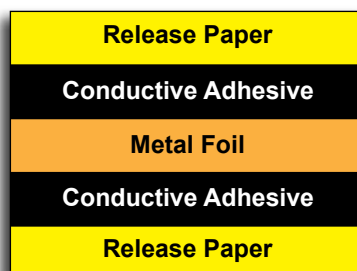

SMT Construction

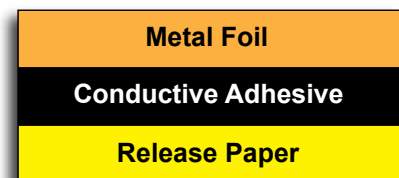

EMI/RFI Shielding

SMT & DMT Series Metal Foil Adhesive Tapes

Single Sided Tape Specifications

DTi Part Number	Structure	Thickness		Width		Length		Contact Resistivity (Ω/sq.)	Adhesive Strength (gf/25mm)
		inches	mm	inches	mm	feet	m		
SMTAL007	Al Foil Conductive Adhesive Release Paper	0.0028	0.070	39.37	1000	164	50	≤0.10	≥800
SMTAL005	Al Foil Conductive Adhesive Release Paper	0.0022	0.055	39.37	1000	164	50	≤0.05	≥600
SMTAL010N	Al Foil Non-Conductive Adhesive Release Paper	0.0039	0.100	19.69	500	164	50	-	≥1000
SMTALP007N-PET	Polyester Film Al Foil Conductive Adhesive Release Paper	0.0028	0.070	39.37	1000	164	50	-	≥1800
SMTCU007	Cu Foil Conductive Adhesive Release Paper	0.0028	0.0700	25.59	650	82	25	≤0.10	≥900
SMTCU0075N	Cu Foil Non-Conductive Adhesive Release Paper	0.0030	0.075	25.59	650	82	25	-	≥1000

Double Sided Tape Specifications

DTi Part Number	Structure	Thickness		Width		Length		Contact Resistivity (Ω/sq.)	Adhesive Strength (gf/25mm)
		inches	mm	inches	mm	feet	m		
DMTAL005	Conductive Adhesive Al Foil Conductive Adhesive Release Paper	0.0020	0.050	19.69	500	164	50	≤0.10	≥500
DMTAL009	Conductive Adhesive Al Foil Conductive Adhesive Release Paper	0.0035	0.090	19.69	500	164	50	≤0.10	≥900
DMTAL009F	Conductive Adhesive Al Foil Conductive Adhesive Release Paper	0.0035	0.090	19.69	500	164	50	≤0.20	≥850
DMTCU010	Conductive Adhesive Cu Foil Conductive Adhesive Release Paper	0.0039	0.100	25.59	650	82	25	≤0.10	≥900

Ordering Examples

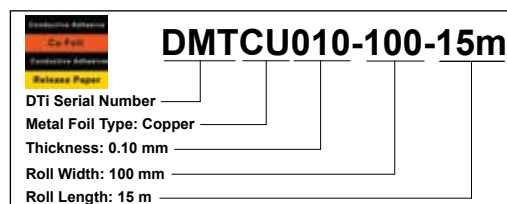
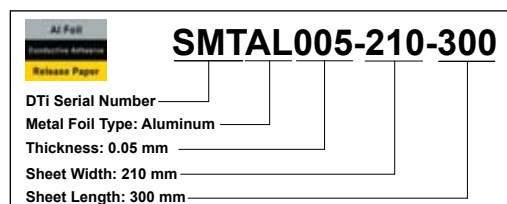

Custom layer configurations available. Contact Customer Service for information and samples.

EMI/RFI Shielding

S Series Stamped Finger Gaskets

S Series Stamped Finger Gaskets combine high levels of EMI effectiveness with finger contact and low closure force properties. **Beryllium Copper (BeCu C17200 alloy)** offers high performance EMI shielding qualities over a broad frequency range. **S Series Gaskets** can be plated with tin or gold. Strips can be soft soldered or resistance welded, edge or slot mounted, use a track and rivet system, or come with pressure sensitive adhesive.



Features and Benefits:

- High tensile strength
- Excellent anti-corrosion properties
- Superb electrical conductivity
- Shielding Effectiveness:
Min. 90dB from 1MHz to 1GHz
- Contact Resistance: Max. 0.05Ω

Applications:

- Chassis covers
- Front panels
- Back planes
- Plug-in units



Physical Properties	S Series BeCu
Tensile Strength	180 ksi Min.
Yield Strength	155 ksi Min.
Hardness	Rockwell C36 ~ C43
Temperature Range	-30°C ~ 105°C
Elongation in 2 inches	48%

Chemical Composition	
Be	1.8 ~ 2.0%
Co + Ni	> 0.2%
Co + Ni + Fe	≤ 0.6%
Pb	≤ 0.02%
Cu	Balance

Finish Plating	Recommended Mating and Mounting Surface
Cu	Brass, Cu, Ni-Cu Alloy, Monel, Stainless Steel, Ag
Ni	Brass, Carbon Steel, Cu, Fe, Stainless Steel, Sn
Sn	Al, Al Alloy, Be, Carbon Steel, Ni, Sn, Zn

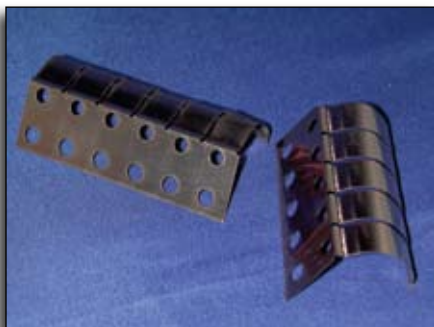

Attachment Options:

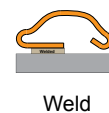

Available in standard or custom design configurations

Fraction Conversion Chart

Fraction of an inch	Decimal of an inch	Millimeters	Fraction of an inch	Decimal of an inch	Millimeters
1/32	0.031	0.794	17/32	0.531	13.494
1/16	0.063	1.588	9/16	0.563	14.288
3/32	0.094	2.381	19/32	0.594	15.081
1/8	0.125	3.175	5/8	0.625	15.875
5/32	0.156	3.969	21/32	0.656	16.669
3/16	0.188	4.763	11/16	0.688	17.463
7/32	0.219	5.556	23/32	0.719	18.256
1/4	0.250	6.350	3/4	0.750	19.050
9/32	0.281	7.144	25/32	0.781	19.844
5/16	0.313	7.938	13/16	0.813	20.638
11/32	0.344	8.731	27/32	0.844	21.431
3/8	0.375	9.525	7/8	0.875	22.225
13/32	0.406	10.319	29/32	0.906	23.019
7/16	0.438	11.113	15/16	0.938	23.813
15/32	0.469	11.906	31/32	0.969	24.606
1/2	0.500	12.700	1	1.000	25.400

Length

1 in = 25.4 mm = 2.54 cm
 1 ft = 30.48 cm = 0.3048 m

Area

1 in² = 6.4516 cm²
 1 ft² = 0.0929 m²

Volume

1 in³ = 16.387 cm³
 1 ft³ = 0.0283 m³
 1 fluid oz = 29.574 ml
 1 gal = 3.7854 l

Weight

1 oz = 28.35 g
 1 lb = 0.4536 kg = 453.6 g

Sheet Metal Gage Chart

Gage	Sheet Steel	Stainless Steel	Gage	Sheet Steel	Stainless Steel
24	0.024	0.025	12	0.105	0.109
23	0.027	0.028	11	0.120	0.125
22	0.030	0.031	10	0.135	0.141
21	0.033	0.034	9	0.150	0.156
20	0.036	0.038	8	0.164	0.172
19	0.042	0.044	7	0.179	0.188
18	0.048	0.050	6	0.194	0.203
17	0.054	0.056	5	0.209	0.219
16	0.060	0.063	4	0.224	0.234
15	0.067	0.070	3	0.239	0.250
14	0.075	0.078	2	-	0.266
13	0.090	0.094	1	-	0.281

Temperature

°F = 9/5°C + 32
 °C = 5/9(°F-32)

For three decades, Device Technologies has been powder coating linear (reel-to-reel) substrates for its own Spring-Fast® line of wire protection grommet edging. The powder coatings work so well for us, we've decided to offer linear powder coating services to other industrial users.

Our powder coating method is a unique, reel-to-reel process. It applies thermoplastic resins such as nylon and polyethylene, or thermoset resins such as polyester and epoxy to linear metallic substrates such as wire, cable, stampings, or steel strip. The coating can be applied to the entire surface, or selectively to part of the surface creating functional and/or decorative finishes.

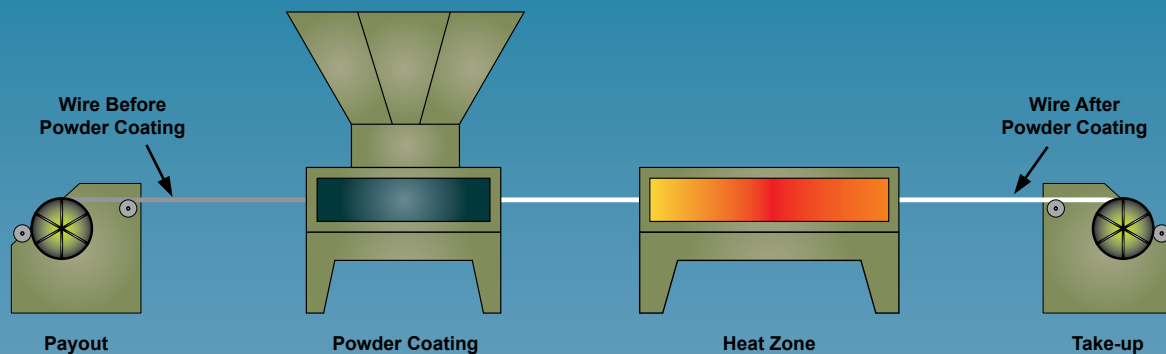

Capabilities and Features of Our Powder Coating Service

The near 100% transfer efficiency rate of Device Technologies' process delivers a fast and efficient application of a smooth, protective coating to a variety of wire, cable, stampings and metal strip. Functional finishes include end products that require durable surface protection for electrical insulation or corrosion resistance. Decorative finishes are also durable and can be used to create virtually any color as well as special effects.



Selectively Coated

- Thermoset and thermoplastic resins
- Specialty electrical insulation and corrosion resistant coatings
- Decorative coatings
- Flexible coatings
- Full and selective coating
- Depositions from light dusting to heavier builds

For more information and to see a video demonstration, go to:

www.devicetech.com/powder



Variety of Colors



Fully Coated

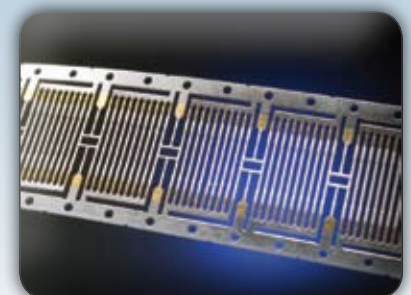

Selectively Coated Stamping

COLLABORATIVE PRODUCT DESIGN-DEVELOPMENT MANUFACTURING



DUAL & CROSS HEAD EXTRUSIONS

- Thermoset and Thermoplastic Materials
- Standard & Custom Profiles

STAMPING

PLASTIC MOLDING

PRECUT LENGTHS

ASSEMBLY AND KITS



We at Device Technologies collaborate with our customers to develop new products and provide value engineering solutions from concept and design through manufacturing, verification, and validation in accordance to our AS and ISO quality process standards. Our solutions are developed to perform and provide a particular function or set of functions effectively and reliably and to be manufactured economically for our customers. Our collaborative solutions include, but are not limited to, wire abrasion protection, cable management, enclosure sealing and EMI / RFI shielding.





Device Technologies, Inc.

www.devicetech.com

For information and free samples, please contact customer service at +1 (508)229-2000, ext. 130, or email to customerservice@devicetech.com.

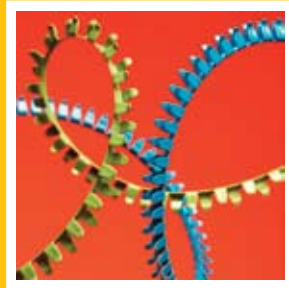

ISO 9001: AS9100 Certified ■ DFARS Compliant ■ Cage Code 0HES0

DTi device technologies, inc.



Copyright 2010 Device Technologies, Inc.

CA-2010/2M-5K