



**R-Loc**<sup>®</sup>

One Stop Solution for all Clamping Requirements....

**Raychem RPG Pvt. Ltd.** 

(A Tyco Electronics - RPG Enterprises JV)

**Company Profile**

Raychem RPG Pvt. Ltd. is a **50:50 Joint Venture** company between **Tyco Electronics, USA**. (a Fortune 500 Company) and **RPG Enterprises, India** (one of the top 10 business houses in India).

**Tyco Electronics, U.S.A.** is a US\$ 15 billion conglomerate & World's largest manufacturer for passive components business and Engineering Products & Services.

**RPG Enterprises, India** is one of the Top 10 business houses in India with interests in Power Generation, Distribution & Transmission, Cables, IT & Communication, Life Sciences, Automotive, Retail & Entertainment Sectors and a revenue exceeding US\$ 4 billion.



**Raychem RPG was incorporated in 1984.** The company has been involved in technologies serving the infrastructure sector, supplying multi business engineering products and solutions worldwide. Constant innovation is a way of life at Raychem RPG that leads to new solutions to meet new challenges of the future. A whopping CAGR of 40% for last 5 years stands testimony to this spirit of the company.

Raychem RPG has 5 state-of-the-art manufacturing plants spanned across India. Our Core competencies lie into the manufacturing of Heat Shrinkable Cable Accessories products, Fibre Cable Accessories, Transformers, Gas Meters, Cathodic Protection Systems, Customized engineering components and Cable Clamping Products.

Raychem RPG Limited is an ISO 9001 & ISO 14001 company, certified by Lloyd's Register of Quality Assurance Limited, UK.

**Our Vision**

- **We will grow and attain sustained leadership position in all our chosen lines of business.**
- **We will win the respect of all our stakeholders.**

**Core Value**

- Focus on customers.
- Develop a committed and responsive community of Employees, Distributors and Vendors.
- Embrace growth and productivity through Innovation and Entrepreneurship.
- Communicate openly and demonstrate integrity in all our activities.
- Demonstrate passion for performance through anticipation, speed and flexibility.
- Protect the environment and contribute to society around us.

**Quality Approvals**



<b>INDEX</b>		<b>Page</b>
<b>Product Applications</b>		<b>04</b>
<b>Stainless Steel Cable Ties</b>		<b>05</b>
Stainless Steel Ball Lock Cable Ties, Uncoated		06
Stainless Steel Ball Lock Cable Ties, Coated		07
Stainless Steel Ball Lock Cable Ties, Heavy Duty		08
Ball Lock Cable Ties Features		09
Wedge Lock Mechanism		09
MultiColour Spectrum Ties		09
Stainless Steel Ball Lock Cable Ties, Spring Type Uncoated		10
Stainless Steel Ball Lock Cable Ties, Spring Type Coated		11
Stainless Steel Cable Ties, Ladder Type, Uncoated		12
Stainless Steel Cable Ties, Ladder Type, Coated		13
Stainless Steel Cable Ties, Releasable Type, Uncoated		14
Stainless Steel Cable Ties, Releasable Type, PPA 571 Coated		15
<b>Bands (Straps) and Buckles (Clips) Systems</b>		<b>16</b>
Stainless Steel Band for Corrosive Atmospheric Application		16
Stainless Steel Band for High Tensile Application		17
Utility Bands		18
Heavy Duty Bands		19
Bands & Buckles Application Process		19
PPA 571 Coated Bands for Highly Corrosive Applications		20
PVC Coated Bands		21
All Purpose Bands-for easy and fast installation		22
Aluminium Perforated Strip-for easy and fast installation		23
Tools		23
Buckles-Jaw Type		24
Buckles-Wing Type		24
Buckles-Screw Type		25
Sign Mounting Brackets		25
<b>Pre-Cut Band and Buckle System</b>		<b>26</b>
Center Punch Preformed Clamps		26
Pre-cut Assembled Straps - Jaw Type		27
Pre-cut Assembled Straps - Wing Type		27
<b>Identification System</b>		<b>28</b>
R-Loc Alfa-Numeric Characters (Marker Tags)		28
Carrier Strips - Coated / Uncoated		28
R-Loc Marker Plates & Tags		29
R-Loc Custom Marked Tags (Laser & Embossed)		29
<b>Quality Systems &amp; Type Approvals</b>		<b>30</b>
Type Approvals		30
Rigorous Tests & Physical Properties of R-Loc Clamping Products		30
Laboratory Testing Facilities for R-Loc Clamping Products		30



## Product Applications



**Signages and Signals**



**Shipping**



**Oil & Petrochemical**



**Refineries & Industries**



**Power Utilities**



**Locomotive**



**Communication**



**Automotive**



**Cable installations**



## Stainless Steel Cable Ties

R-Loc Stainless Steel cable ties provide solutions to all your clamping problems. R-Loc cable ties are used world-wide to secure POLES, CABLES, PIPES and perform host of other clamping functions.

“R-Loc” cable ties not only have high resistance to heat but can also stand the test of salts and acids. They are the perfect choice for Indoor, Outdoor and Underground applications. R-Loc cable ties have rounded edges and are safe for handling. To ensure the security of your clamping functions, R-Loc ties are subjected to rigorous physical and chemical testing. Cable ties are randomly subjected to loop tensile strength.

R-Loc Cable ties are offered in both AISI 304 (EN DIN 1.4301) and AISI 316 (EN DIN 1.4401) Stainless Steel. We provide customised solutions including designing, testing, validation and stimulation through our in house testing facilities.

### Types of SS Cable Ties

#### Ball Lock Cable Tie

**BUXX-XXX BCXX-XXX**



#### Spring Type Ball Lock Cable Tie

**BUzXX-XXX BCzXX-XXX**

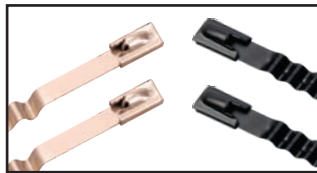

#### Ladder Cable Tie

**LUXX-XXX LCXX-XXX**



#### Reasable Cable Tie

**RUXX-XXX RCpXX-XXX**

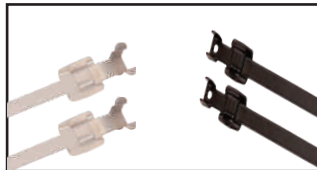

#### Designation of locking arrangement :

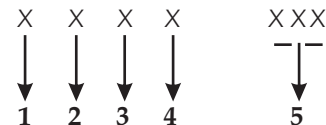

1. R - For Releasable Type  
L - For Ladder Type  
B - For Roller Ball Type
2. U - Un-coated, C- Coated, Cp - PPA Coated  
Uz - Spring Un-coated, Cz- Spring Coated
3. Indicates Width
4. Indicates Grade of Material
5. Indicates Length of Tie.

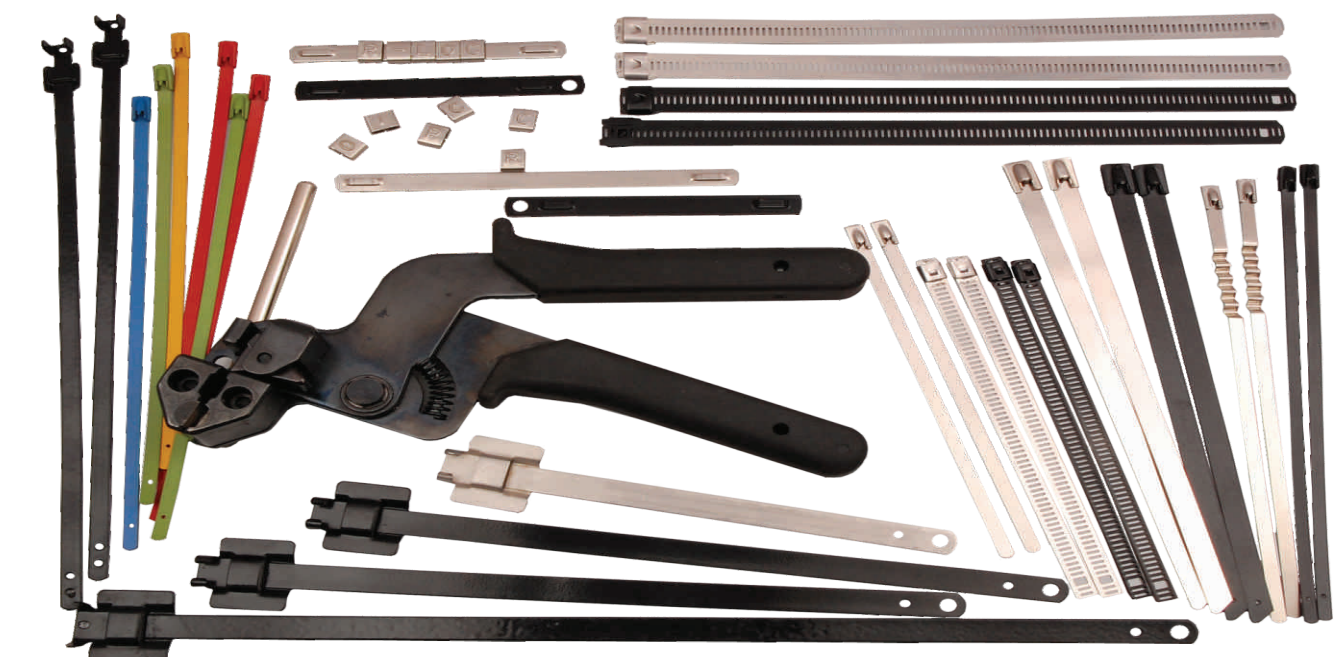

## Stainless Steel Ball Lock Cable Ties, Uncoated

### Technical Information:

- Material** A) 316 grade non-magnetic stainless steel  
B) 304 grade non-magnetic stainless steel
- Temperature Range** - 80°C to + 500°C
- Surface Finish** Metallic
- Flamability rating** Absolutely fireproof. Halogen free and UV-resistant

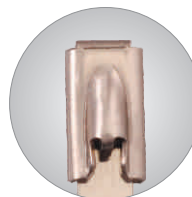

### Ball Lock Uncoated-SS304, 4.6mm width

Part No.	Material	Width		Length		Thickness		Max Diameter Single Loop		Minimum Loop Tensile Strength		Package Quantity
		In	mm	In	mm	In	mm	In	mm	N	lbs	
BU44-100	SS304	0.18	4.6	4	100	0.01	0.25	1.1	27	667	150	100/bag
BU44-150	SS304	0.18	4.6	6	150	0.01	0.25	1.7	43	667	150	100/bag
BU44-200	SS304	0.18	4.6	8	200	0.01	0.25	2.3	59	667	150	100/bag
BU44-260	SS304	0.18	4.6	10	260	0.01	0.25	3.1	78	667	150	100/bag
BU44-360	SS304	0.18	4.6	14	360	0.01	0.25	4.3	110	667	150	100/bag
BU44-520	SS304	0.18	4.6	20	520	0.01	0.25	6.3	161	667	150	100/bag
BU44-620	SS304	0.18	4.6	24	620	0.01	0.25	7.6	192	667	150	100/bag
BU44-840	SS304	0.18	4.6	33	840	0.01	0.25	10.4	263	667	150	100/bag
BU44-1000	SS304	0.18	4.6	39	1000	0.01	0.25	12.3	313	667	150	100/bag

### Ball Lock Uncoated-SS316, 4.6mm width

Part No.	Material	Width		Length		Thickness		Max Diameter Single Loop		Minimum Loop Tensile Strength		Package Quantity
		In	mm	In	mm	In	mm	In	mm	N	lbs	
BU46-100	SS316	0.18	4.6	4	100	0.01	0.25	1.1	27	667	150	100/bag
BU46-150	SS316	0.18	4.6	6	150	0.01	0.25	1.7	43	667	150	100/bag
BU46-200	SS316	0.18	4.6	8	200	0.01	0.25	2.3	59	667	150	100/bag
BU46-260	SS316	0.18	4.6	10	260	0.01	0.25	3.1	78	667	150	100/bag
BU46-360	SS316	0.18	4.6	14	360	0.01	0.25	4.3	110	667	150	100/bag
BU46-520	SS316	0.18	4.6	20	520	0.01	0.25	6.3	161	667	150	100/bag
BU46-620	SS316	0.18	4.6	24	620	0.01	0.25	7.6	192	667	150	100/bag
BU46-840	SS316	0.18	4.6	33	840	0.01	0.25	10.4	263	667	150	100/bag
BU46-1000	SS316	0.18	4.6	39	1000	0.01	0.25	12.3	313	667	150	100/bag

### Ball Lock Uncoated-SS304, 7.9mm width

Part No.	Material	Width		Length		Thickness		Max Diameter Single Loop		Minimum Loop Tensile Strength		Package Quantity
		In	mm	In	mm	In	mm	In	mm	N	lbs	
BU74-100	SS304	0.31	7.9	4	100	0.01	0.25	1.1	27	1335	300	100/bag
BU74-150	SS304	0.31	7.9	6	150	0.01	0.25	1.7	43	1335	300	100/bag
BU74-200	SS304	0.31	7.9	8	200	0.01	0.25	2.3	59	1335	300	100/bag
BU74-260	SS304	0.31	7.9	10	260	0.01	0.25	3.1	78	1335	300	100/bag
BU74-360	SS304	0.31	7.9	14	360	0.01	0.25	4.3	110	1335	300	100/bag
BU74-520	SS304	0.31	7.9	20	520	0.01	0.25	6.3	161	1335	300	100/bag
BU74-620	SS304	0.31	7.9	24	620	0.01	0.25	7.6	192	1335	300	100/bag
BU74-840	SS304	0.31	7.9	33	840	0.01	0.25	10.4	263	1335	300	100/bag
BU74-1000	SS304	0.31	7.9	39	1000	0.01	0.25	12.3	313	1335	300	100/bag

### Ball Lock Uncoated-SS316, 7.9mm width

Part No.	Material	Width		Length		Thickness		Max Diameter Single Loop		Minimum Loop Tensile Strength		Package Quantity
		In	mm	In	mm	In	mm	In	mm	N	lbs	
BU76-100	SS316	0.31	7.9	4	100	0.01	0.25	1.1	27	1335	300	100/bag
BU76-150	SS316	0.31	7.9	6	150	0.01	0.25	1.7	43	1335	300	100/bag
BU76-200	SS316	0.31	7.9	8	200	0.01	0.25	2.3	59	1335	300	100/bag
BU76-260	SS316	0.31	7.9	10	260	0.01	0.25	3.1	78	1335	300	100/bag
BU76-360	SS316	0.31	7.9	14	360	0.01	0.25	4.3	110	1335	300	100/bag
BU76-520	SS316	0.31	7.9	20	520	0.01	0.25	6.3	161	1335	300	100/bag
BU76-620	SS316	0.31	7.9	24	620	0.01	0.25	7.6	192	1335	300	100/bag
BU76-840	SS316	0.31	7.9	33	840	0.01	0.25	10.4	263	1335	300	100/bag
BU76-1000	SS316	0.31	7.9	39	1000	0.01	0.25	12.3	313	1335	300	100/bag



## Stainless Steel Ball Lock Cable Ties, Coated

### Technical Information:

**Material** A) 316 grade non-magnetic stainless steel  
B) 304 grade non-magnetic stainless steel

**Temperature Range** - 80°C to +150°C

**Surface Finish** Pure Polyester & Epoxy Coating

**Flamability rating** Fireproof, Halogen Free and UV-resistant



### Ball Lock Coated-SS304, 4.6mm width

Part No.	Material	Width		Length		Thickness		Max Diameter Single Loop		Minimum Loop Tensile Strength		Package Quantity
		In	mm	In	mm	In	mm	In	mm	N	lbs	
BC44-100	SS304	0.18	4.6	4	100	0.01	0.25	1.1	27	667	150	100/bag
BC44-150	SS304	0.18	4.6	6	150	0.01	0.25	1.7	43	667	150	100/bag
BC44-200	SS304	0.18	4.6	8	200	0.01	0.25	2.3	59	667	150	100/bag
BC44-260	SS304	0.18	4.6	10	260	0.01	0.25	3.1	78	667	150	100/bag
BC44-360	SS304	0.18	4.6	14	360	0.01	0.25	4.3	110	667	150	100/bag
BC44-520	SS304	0.18	4.6	20	520	0.01	0.25	6.3	161	667	150	100/bag
BC44-620	SS304	0.18	4.6	24	620	0.01	0.25	7.6	192	667	150	100/bag
BC44-840	SS304	0.18	4.6	33	840	0.01	0.25	10.4	263	667	150	100/bag
BC44-1000	SS304	0.18	4.6	39	1000	0.01	0.25	12.3	313	667	150	100/bag

### Ball Lock Coated-SS316, 4.6mm width

Part No.	Material	Width		Length		Thickness		Max Diameter Single Loop		Minimum Loop Tensile Strength		Package Quantity
		In	mm	In	mm	In	mm	In	mm	N	lbs	
BC46-100	SS316	0.18	4.6	4	100	0.01	0.25	1.1	27	667	150	100/bag
BC46-150	SS316	0.18	4.6	6	150	0.01	0.25	1.7	43	667	150	100/bag
BC46-200	SS316	0.18	4.6	8	200	0.01	0.25	2.3	59	667	150	100/bag
BC46-260	SS316	0.18	4.6	10	260	0.01	0.25	3.1	78	667	150	100/bag
BC46-360	SS316	0.18	4.6	14	360	0.01	0.25	4.3	110	667	150	100/bag
BC46-520	SS316	0.18	4.6	20	520	0.01	0.25	6.3	161	667	150	100/bag
BC46-620	SS316	0.18	4.6	24	620	0.01	0.25	7.6	192	667	150	100/bag
BC46-840	SS316	0.18	4.6	33	840	0.01	0.25	10.4	263	667	150	100/bag
BC46-1000	SS316	0.18	4.6	39	1000	0.01	0.25	12.3	313	667	150	100/bag

### Ball Lock Coated-SS304, 7.9mm width

Part No.	Material	Width		Length		Thickness		Max Diameter Single Loop		Minimum Loop Tensile Strength		Package Quantity
		In	mm	In	mm	In	mm	In	mm	N	lbs	
BC74-100	SS304	0.31	7.9	4	100	0.01	0.25	1.1	27	1335	300	100/bag
BC74-150	SS304	0.31	7.9	6	150	0.01	0.25	1.7	43	1335	300	100/bag
BC74-200	SS304	0.31	7.9	8	200	0.01	0.25	2.3	59	1335	300	100/bag
BC74-260	SS304	0.31	7.9	10	260	0.01	0.25	3.1	78	1335	300	100/bag
BC74-360	SS304	0.31	7.9	14	360	0.01	0.25	4.3	110	1335	300	100/bag
BC74-520	SS304	0.31	7.9	20	520	0.01	0.25	6.3	161	1335	300	100/bag
BC74-620	SS304	0.31	7.9	24	620	0.01	0.25	7.6	192	1335	300	100/bag
BC74-840	SS304	0.31	7.9	33	840	0.01	0.25	10.4	263	1335	300	100/bag
BC74-1000	SS304	0.31	7.9	39	1000	0.01	0.25	12.3	313	1335	300	100/bag

### Ball Lock Coated-SS316, 7.9mm width

Part No.	Material	Width		Length		Thickness		Max Diameter Single Loop		Minimum Loop Tensile Strength		Package Quantity
		In	mm	In	mm	In	mm	In	mm	N	lbs	
BC76-100	SS316	0.31	7.9	4	100	0.01	0.25	1.1	27	1335	300	100/bag
BC76-150	SS316	0.31	7.9	6	150	0.01	0.25	1.7	43	1335	300	100/bag
BC76-200	SS316	0.31	7.9	8	200	0.01	0.25	2.3	59	1335	300	100/bag
BC76-260	SS316	0.31	7.9	10	260	0.01	0.25	3.1	78	1335	300	100/bag
BC76-360	SS316	0.31	7.9	14	360	0.01	0.25	4.3	110	1335	300	100/bag
BC76-520	SS316	0.31	7.9	20	520	0.01	0.25	6.3	161	1335	300	100/bag
BC76-620	SS316	0.31	7.9	24	620	0.01	0.25	7.6	192	1335	300	100/bag
BC76-840	SS316	0.31	7.9	33	840	0.01	0.25	10.4	263	1335	300	100/bag
BC76-1000	SS316	0.31	7.9	39	1000	0.01	0.25	12.3	313	1335	300	100/bag

## Stainless Steel Ball Lock Cable Ties, Heavy Duty

### Technical Information:

**Material** A) 316 grade non-magnetic stainless steel  
B) 304 grade non-magnetic stainless steel

**Temperature Range** - 80°C to + 500°C

**Surface Finish** Metallic (Uncoated), Polyester & Epoxy (Coated)

**Flamability rating** Absolutely fireproof, UV-resistant and Halogen free



### Ball Lock Uncoated-SS304, 12.7mm width

Part No.	Material	Width		Length		Thickness		Max Diameter Single Loop		Minimum Loop Tensile Strength		Package Quantity
		In	mm	In	mm	In	mm	In	mm	N	lbs	
BU124-100	SS304	0.50	12.7	4	100	0.02	0.40	1.1	27	3115	700	100/bag
BU124-150	SS304	0.50	12.7	6	150	0.02	0.40	1.7	43	3115	700	100/bag
BU124-200	SS304	0.50	12.7	8	200	0.02	0.40	2.3	59	3115	700	100/bag
BU124-260	SS304	0.50	12.7	10	260	0.02	0.40	3.1	78	3115	700	100/bag
BU124-360	SS304	0.50	12.7	14	360	0.02	0.40	4.3	110	3115	700	100/bag
BU124-520	SS304	0.50	12.7	20	520	0.02	0.40	6.3	161	3115	700	100/bag
BU124-620	SS304	0.50	12.7	24	620	0.02	0.40	7.6	192	3115	700	100/bag
BU124-840	SS304	0.50	12.7	33	840	0.02	0.40	10.4	263	3115	700	100/bag
BU124-1000	SS304	0.50	12.7	39	1000	0.02	0.40	12.3	313	3115	700	100/bag

### Ball Lock-Uncoated-SS316, 12.7mm width

Part No.	Material	Width		Length		Thickness		Max Diameter Single Loop		Minimum Loop Tensile Strength		Package Quantity
		In	mm	In	mm	In	mm	In	mm	N	lbs	
BU126-100	SS316	0.50	12.7	4	100	0.02	0.40	1.1	27	3115	700	100/bag
BU126-150	SS316	0.50	12.7	6	150	0.02	0.40	1.7	43	3115	700	100/bag
BU126-200	SS316	0.50	12.7	8	200	0.02	0.40	2.3	59	3115	700	100/bag
BU126-260	SS316	0.50	12.7	10	260	0.02	0.40	3.1	78	3115	700	100/bag
BU126-360	SS316	0.50	12.7	14	360	0.02	0.40	4.3	110	3115	700	100/bag
BU126-520	SS316	0.50	12.7	20	520	0.02	0.40	6.3	161	3115	700	100/bag
BU126-620	SS316	0.50	12.7	24	620	0.02	0.40	7.6	192	3115	700	100/bag
BU126-840	SS316	0.50	12.7	33	840	0.02	0.40	10.4	263	3115	700	100/bag
BU126-1000	SS316	0.50	12.7	39	1000	0.02	0.40	12.3	313	3115	700	100/bag

### Ball Lock-Coated-SS304, 12.7mm width

Part No.	Material	Width		Length		Thickness		Max Diameter Single Loop		Minimum Loop Tensile Strength		Package Quantity
		In	mm	In	mm	In	mm	In	mm	N	lbs	
BC124-100	SS304	0.50	12.7	4	100	0.02	0.40	1.1	27	3115	700	100/bag
BC124-150	SS304	0.50	12.7	6	150	0.02	0.40	1.7	43	3115	700	100/bag
BC124-200	SS304	0.50	12.7	8	200	0.02	0.40	2.3	59	3115	700	100/bag
BC124-260	SS304	0.50	12.7	10	260	0.02	0.40	3.1	78	3115	700	100/bag
BC124-360	SS304	0.50	12.7	14	360	0.02	0.40	4.3	110	3115	700	100/bag
BC124-520	SS304	0.50	12.7	20	520	0.02	0.40	6.3	161	3115	700	100/bag
BC124-620	SS304	0.50	12.7	24	620	0.02	0.40	7.6	192	3115	700	100/bag
BC124-840	SS304	0.50	12.7	33	840	0.02	0.40	10.4	263	3115	700	100/bag
BC124-1000	SS304	0.50	12.7	39	1000	0.02	0.40	12.3	313	3115	700	100/bag

### Ball Lock Coated-SS316, 12.7mm width

Part No.	Material	Width		Length		Thickness		Max Diameter Single Loop		Minimum Loop Tensile Strength		Package Quantity
		In	mm	In	mm	In	mm	In	mm	N	lbs	
BC126-100	SS316	0.50	12.7	4	100	0.02	0.40	1.1	27	3115	700	100/bag
BC126-150	SS316	0.50	12.7	6	150	0.02	0.40	1.7	43	3115	700	100/bag
BC126-200	SS316	0.50	12.7	8	200	0.02	0.40	2.3	59	3115	700	100/bag
BC126-260	SS316	0.50	12.7	10	260	0.02	0.40	3.1	78	3115	700	100/bag
BC126-360	SS316	0.50	12.7	14	360	0.02	0.40	4.3	110	3115	700	100/bag
BC126-520	SS316	0.50	12.7	20	520	0.02	0.40	6.3	161	3115	700	100/bag
BC126-620	SS316	0.50	12.7	24	620	0.02	0.40	7.6	192	3115	700	100/bag
BC126-840	SS316	0.50	12.7	33	840	0.02	0.40	10.4	263	3115	700	100/bag
BC126-1000	SS316	0.50	12.7	39	1000	0.02	0.40	12.3	313	3115	700	100/bag



## Ball Lock Cable Tie Features

- Self Locking mechanism for fast and easy installation
- Rounded edges and Smooth Surfaces for safe handling
- Flame Retardant, Non-Toxic and Halogen Free
- Fully enclosed head does not allow dirt or grit to interfere with locking mechanism
- Ideal for applications where Corrosion, Vibration, Radiation and Temperature extremes are concerned
- Cable Tie Lock Mechanism Ball made of SS316 ensuring perfect lock in harsh corrosive conditions

## Wedge Lock Mechanism

### A) Initial Position

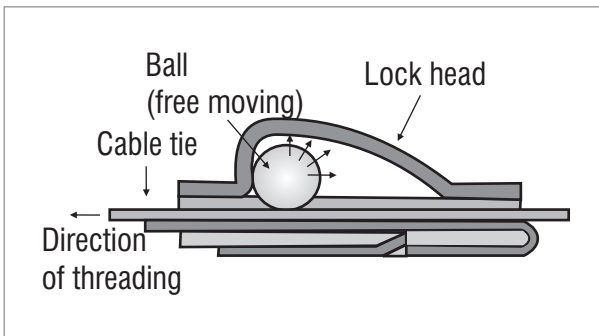

### B) Wedge Lock Position

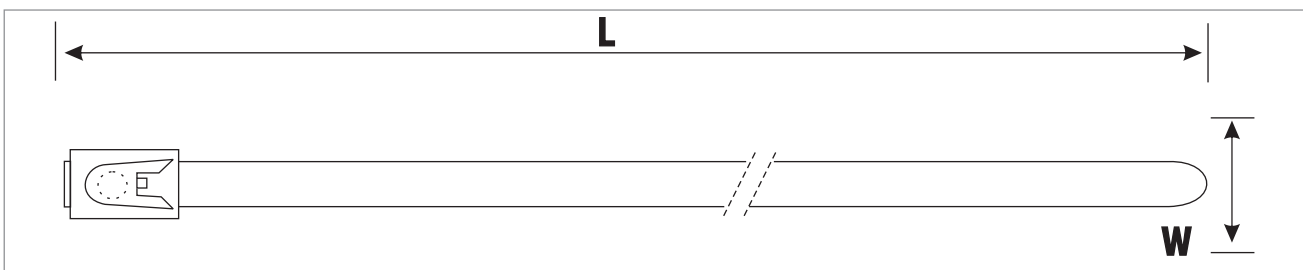
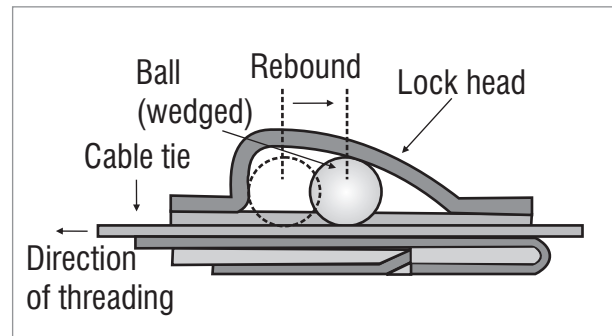

## Multicolour Spectrum Ties

- We also provide Stainless Steel Ball Lock Ties in various colour coatings
- Spectrum Ties can be used for easy identification for various phase lines of cables and matching colour surroundings

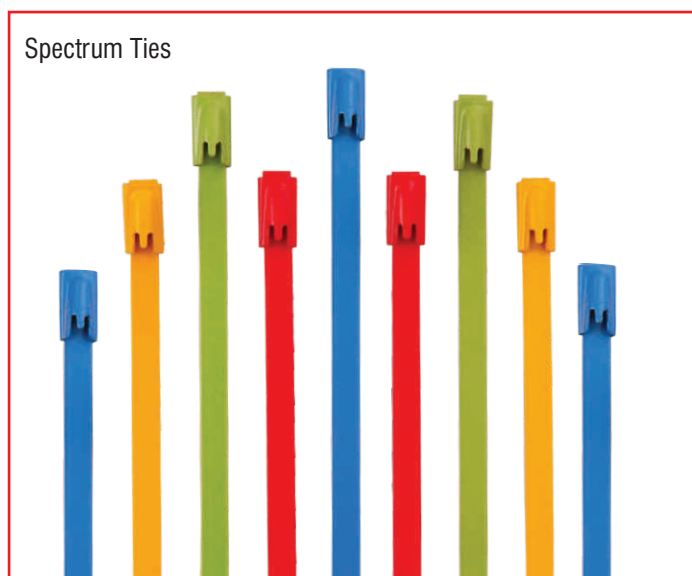

**Multicolour Spectrum Ball Lock Ties**

**Stainless Steel Ball Lock Cable Ties, Spring Type Uncoated**

**Technical Information:**

- Spring Ties** The unique spring form maintains greater installed tension on non-resilient objects
- Application** Where tensions on solid object must be maintained.
- Material** A) 316 grade non-magnetic stainless steel  
B) 304 grade non-magnetic stainless steel
- Temperature Range** - 80°C to + 500°C
- Surface Finish** Metallic
- Flamability rating** Absolutely fireproof, Halogen free and UV-resistant



**Ball Lock Spring Type Uncoated-SS304, 4.6mm width**

Part No.	Material	Width		Length		Thickness		Max Diameter Single Loop		Minimum Loop Tensile Strength		Package Quantity
		In	mm	In	mm	In	mm	In	mm	N	lbs	
BUz44-200	SS304	0.18	4.6	8	200	0.01	0.25	2.0	50	667	150	100/bag
BUz44-260	SS304	0.18	4.6	10	260	0.01	0.25	2.7	69	667	150	100/bag
BUz44-360	SS304	0.18	4.6	14	360	0.01	0.25	4.0	102	667	150	100/bag
BUz44-520	SS304	0.18	4.6	20	520	0.01	0.25	6.0	152	667	150	100/bag
BUz44-680	SS304	0.18	4.6	27	680	0.01	0.25	7.5	190	667	150	100/bag
BUz44-840	SS304	0.18	4.6	33	840	0.01	0.25	10.0	254	667	150	100/bag
BUz44-1000	SS304	0.18	4.6	39	1000	0.01	0.25	11.8	300	667	150	100/bag

**Ball Lock Spring Type Uncoated-SS316, 4.6mm width**

Part No.	Material	Width		Length		Thickness		Max Diameter Single Loop		Minimum Loop Tensile Strength		Package Quantity
		In	mm	In	mm	In	mm	In	mm	N	lbs	
BUz46-200	SS316	0.18	4.6	8	200	0.01	0.25	2.0	50	667	150	100/bag
BUz46-260	SS316	0.18	4.6	10	260	0.01	0.25	2.7	69	667	150	100/bag
BUz46-360	SS316	0.18	4.6	14	360	0.01	0.25	4.0	102	667	150	100/bag
BUz46-520	SS316	0.18	4.6	20	520	0.01	0.25	6.0	152	667	150	100/bag
BUz46-680	SS316	0.18	4.6	24	620	0.01	0.25	7.5	190	667	150	100/bag
BUz46-840	SS316	0.18	4.6	33	840	0.01	0.25	10.0	254	667	150	100/bag
BUz46-1000	SS316	0.18	4.6	39	1000	0.01	0.25	11.8	300	667	150	100/bag

**Ball Lock Spring Type Uncoated-SS304, 7.9mm width**

Part No.	Material	Width		Length		Thickness		Max Diameter Single Loop		Minimum Loop Tensile Strength		Package Quantity
		In	mm	In	mm	In	mm	In	mm	N	lbs	
BUz74-200	SS304	0.31	7.9	8	200	0.01	0.25	2.0	50	1335	300	100/bag
BUz74-260	SS304	0.31	7.9	10	260	0.01	0.25	2.7	69	1335	300	100/bag
BUz74-360	SS304	0.31	7.9	14	360	0.01	0.25	4.0	102	1335	300	100/bag
BUz74-520	SS304	0.31	7.9	20	520	0.01	0.25	6.0	152	1335	300	100/bag
BUz74-680	SS304	0.31	7.9	27	680	0.01	0.25	7.5	190	1335	300	100/bag
BUz74-840	SS304	0.31	7.9	33	840	0.01	0.25	10.0	254	1335	300	100/bag
BUz74-1000	SS304	0.31	7.9	39	1000	0.01	0.25	11.8	300	1335	300	100/bag

**Ball Lock Spring Type Uncoated-SS316, 7.9mm width**

Part No.	Material	Width		Length		Thickness		Single Loop		Minimum Loop Tensile Strength		Package Quantity
		In	mm	In	mm	In	mm	In	mm	N	lbs	
BUz76-200	SS316	0.31	7.9	8	200	0.01	0.25	2.0	50	1335	300	100/bag
BUz76-260	SS316	0.31	7.9	10	260	0.01	0.25	2.7	69	1335	300	100/bag
BUz76-360	SS316	0.31	7.9	14	360	0.01	0.25	4.0	102	1335	300	100/bag
BUz76-520	SS316	0.31	7.9	20	520	0.01	0.25	6.0	152	1335	300	100/bag
BUz76-680	SS316	0.31	7.9	27	680	0.01	0.25	7.5	190	1335	300	100/bag
BUz76-840	SS316	0.31	7.9	33	840	0.01	0.25	10.0	254	1335	300	100/bag
BUz76-1000	SS316	0.31	7.9	39	1000	0.01	0.25	11.8	300	1335	300	100/bag



**Stainless Steel Ball Lock Cable Ties, Spring Type Coated**

**Technical Information:**

- Spring Ties** The unique spring form maintains greater installed tension on non-resilient objects
- Application** Where tensions on solid object must be maintained.
- Material** A) 316 grade non-magnetic stainless steel  
B) 304 grade non-magnetic stainless steel
- Temperature Range** - 80°C to + 150°C
- Surface Finish** Pure Polyester & Epoxy Coating
- Flamability rating** Fireproof, Halogen free and UV-resistant



**Ball Lock Spring Type Coated-SS304, 4.6mm width**

Part No.	Material	Width		Length		Thickness		Max Diameter Single Loop		Minimum Loop Tensile Strength		Package Quantity
		In	mm	In	mm	In	mm	In	mm	N	lbs	
BCz44-200	SS304	0.18	4.6	8	200	0.01	0.25	2.0	50	667	150	100/bag
BCz44-260	SS304	0.18	4.6	10	260	0.01	0.25	2.7	69	667	150	100/bag
BCz44-360	SS304	0.18	4.6	14	360	0.01	0.25	4.0	102	667	150	100/bag
BCz44-520	SS304	0.18	4.6	20	520	0.01	0.25	6.0	152	667	150	100/bag
BCz44-680	SS304	0.18	4.6	27	680	0.01	0.25	7.5	190	667	150	100/bag
BCz44-840	SS304	0.18	4.6	33	840	0.01	0.25	10.0	254	667	150	100/bag
BCz44-1000	SS304	0.18	4.6	39	1000	0.01	0.25	11.8	300	667	150	100/bag

**Ball Lock Spring Type Coated-SS316, 4.6mm width**

Part No.	Material	Width		Length		Thickness		Max Diameter Single Loop		Minimum Loop Tensile Strength		Package Quantity
		In	mm	In	mm	In	mm	In	mm	N	lbs	
BCz46-200	SS316	0.18	4.6	8	200	0.01	0.25	2.0	50	667	150	100/bag
BCz46-260	SS316	0.18	4.6	10	260	0.01	0.25	2.7	69	667	150	100/bag
BCz46-360	SS316	0.18	4.6	14	360	0.01	0.25	4.0	102	667	150	100/bag
BCz46-520	SS316	0.18	4.6	20	520	0.01	0.25	6.0	152	667	150	100/bag
BCz46-680	SS316	0.18	4.6	24	620	0.01	0.25	7.5	190	667	150	100/bag
BCz46-840	SS316	0.18	4.6	33	840	0.01	0.25	10.0	254	667	150	100/bag
BCz46-1000	SS316	0.18	4.6	39	1000	0.01	0.25	11.8	300	667	150	100/bag

**Ball Lock Spring Type Coated-SS304, 7.9mm width**

Part No.	Material	Width		Length		Thickness		Max Diameter Single Loop		Minimum Loop Tensile Strength		Package Quantity
		In	mm	In	mm	In	mm	In	mm	N	lbs	
BCz74-200	SS304	0.31	7.9	8	200	0.01	0.25	2.0	50	1335	300	100/bag
BCz74-260	SS304	0.31	7.9	10	260	0.01	0.25	2.7	69	1335	300	100/bag
BCz74-360	SS304	0.31	7.9	14	360	0.01	0.25	4.0	102	1335	300	100/bag
BCz74-520	SS304	0.31	7.9	20	520	0.01	0.25	6.0	152	1335	300	100/bag
BCz74-680	SS304	0.31	7.9	27	680	0.01	0.25	7.5	190	1335	300	100/bag
BCz74-840	SS304	0.31	7.9	33	840	0.01	0.25	10.0	254	1335	300	100/bag
BCz74-1000	SS304	0.31	7.9	39	1000	0.01	0.25	11.8	300	1335	300	100/bag

**Ball Lock Spring Type Coated-SS316, 7.9mm width**

Part No.	Material	Width		Length		Thickness		Max Diameter Single Loop		Minimum Loop Tensile Strength		Package Quantity
		In	mm	In	mm	In	mm	In	mm	N	lbs	
BCz76-200	SS316	0.31	7.9	8	200	0.01	0.25	2.0	50	1335	300	100/bag
BCz76-260	SS316	0.31	7.9	10	260	0.01	0.25	2.7	69	1335	300	100/bag
BCz76-360	SS316	0.31	7.9	14	360	0.01	0.25	4.0	102	1335	300	100/bag
BCz76-520	SS316	0.31	7.9	20	520	0.01	0.25	6.0	152	1335	300	100/bag
BCz76-680	SS316	0.31	7.9	27	680	0.01	0.25	7.5	190	1335	300	100/bag
BCz76-840	SS316	0.31	7.9	33	840	0.01	0.25	10.0	254	1335	300	100/bag
BCz76-1000	SS316	0.31	7.9	39	1000	0.01	0.25	11.8	300	1335	300	100/bag

**Stainless Steel Ladder Type Cable Tie, Uncoated**

**Technical Information:**

**Material** A) 316 grade non-magnetic stainless steel  
B) 304 grade non-magnetic stainless steel

**Temperature Range** - 80°C to + 500°C

**Surface Finish** Metallic

**Flamability rating** Absolutely fireproof, Halogen free and UV-resistant



**Ladder-Uncoated -SS304, 7mm width**

Part No.	Material	Width		Length		Thickness		Max Diameter Single Loop		Minimum Loop Tensile Strength		Package Quantity
		In	mm	In	mm	In	mm	In	mm	N	lbs	
LU74-150	SS304	0.28	7.0	6	150	0.012	0.30	1.9	48	667	150	100/bag
LU74-200	SS304	0.28	7.0	8	200	0.012	0.30	2.5	64	667	150	100/bag
LU74-225	SS304	0.28	7.0	9	225	0.012	0.30	2.8	71	667	150	100/bag
LU74-250	SS304	0.28	7.0	10	250	0.012	0.30	3.1	80	667	150	100/bag
LU74-300	SS304	0.28	7.0	12	300	0.012	0.30	3.8	96	667	150	100/bag
LU74-360	SS304	0.28	7.0	14	360	0.012	0.30	4.5	114	667	150	100/bag
LU74-450	SS304	0.28	7.0	18	450	0.012	0.30	5.6	142	667	150	100/bag
LU74-600	SS304	0.28	7.0	24	600	0.012	0.30	7.5	190	667	150	100/bag
LU74-610	SS304	0.28	7.0	24	610	0.012	0.30	7.6	194	667	150	100/bag
LU74-750	SS304	0.28	7.0	30	750	0.012	0.30	9.4	238	667	150	100/bag
LU74-1000	SS304	0.28	7.0	39	1000	0.012	0.30	12.5	318	667	150	100/bag

**Ladder-Uncoated -SS316, 7mm width**

Part No.	Material	Width		Length		Thickness		Max Diameter Single Loop		Minimum Loop Tensile Strength		Package Quantity
		In	mm	In	mm	In	mm	In	mm	N	lbs	
LU76-150	SS316	0.28	7.0	6	150	0.012	0.30	1.9	48	667	150	100/bag
LU76-200	SS316	0.28	7.0	8	200	0.012	0.30	2.5	64	667	150	100/bag
LU76-225	SS316	0.28	7.0	9	225	0.012	0.30	2.8	71	667	150	100/bag
LU76-250	SS316	0.28	7.0	10	250	0.012	0.30	3.1	80	667	150	100/bag
LU76-300	SS316	0.28	7.0	12	300	0.012	0.30	3.8	96	667	150	100/bag
LU76-360	SS316	0.28	7.0	14	360	0.012	0.30	4.5	114	667	150	100/bag
LU76-450	SS316	0.28	7.0	18	450	0.012	0.30	5.6	142	667	150	100/bag
LU76-600	SS316	0.28	7.0	24	600	0.012	0.30	7.5	190	667	150	100/bag
LU76-610	SS316	0.28	7.0	24	610	0.012	0.30	7.6	194	667	150	100/bag
LU76-750	SS316	0.28	7.0	30	750	0.012	0.30	9.4	238	667	150	100/bag
LU76-1000	SS316	0.28	7.0	39	1000	0.012	0.30	12.5	318	667	150	100/bag

**Ladder -Uncoated-SS304, 12mm width**

Part No.	Material	Width		Length		Thickness		Max Diameter Single Loop		Minimum Loop Tensile Strength		Package Quantity
		In	mm	In	mm	In	mm	In	mm	N	lbs	
LU124-150	SS304	0.47	12.0	6	150	0.012	0.30	1.9	48	1335	300	100/bag
LU124-200	SS304	0.47	12.0	8	200	0.012	0.30	2.5	64	1335	300	100/bag
LU124-225	SS304	0.47	12.0	9	225	0.012	0.30	2.8	71	1335	300	100/bag
LU124-250	SS304	0.47	12.0	10	250	0.012	0.30	3.1	80	1335	300	100/bag
LU124-300	SS304	0.47	12.0	12	300	0.012	0.30	3.8	96	1335	300	100/bag
LU124-360	SS304	0.47	12.0	14	360	0.012	0.30	4.5	114	1335	300	100/bag
LU124-450	SS304	0.47	12.0	18	450	0.012	0.30	5.6	142	1335	300	100/bag
LU124-600	SS304	0.47	12.0	24	600	0.012	0.30	7.5	190	1335	300	100/bag
LU124-610	SS304	0.47	12.0	24	610	0.012	0.30	7.6	194	1335	300	100/bag
LU124-750	SS304	0.47	12.0	30	750	0.012	0.30	9.4	238	1335	300	100/bag
LU124-1000	SS304	0.47	12.0	39	1000	0.012	0.30	12.5	318	1335	300	100/bag

**Ladder -Uncoated-SS316, 12mm width**

Part No.	Material	Width		Length		Thickness		Max Diameter Single Loop		Minimum Loop Tensile Strength		Package Quantity
		In	mm	In	mm	In	mm	In	mm	N	lbs	
LU126-150	SS304	0.47	12.0	6	150	0.012	0.30	1.9	48	1335	300	100/bag
LU126-200	SS304	0.47	12.0	8	200	0.012	0.30	2.5	64	1335	300	100/bag
LU126-225	SS316	0.47	12.0	9	225	0.012	0.30	2.8	71	1335	300	100/bag
LU126-250	SS316	0.47	12.0	10	250	0.012	0.30	3.1	80	1335	300	100/bag
LU126-300	SS316	0.47	12.0	12	300	0.012	0.30	3.8	96	1335	300	100/bag
LU126-360	SS316	0.47	12.0	14	360	0.012	0.30	4.5	114	1335	300	100/bag
LU126-450	SS316	0.47	12.0	18	450	0.012	0.30	5.6	142	1335	300	100/bag
LU126-600	SS316	0.47	12.0	24	600	0.012	0.30	7.5	190	1335	300	100/bag
LU126-610	SS316	0.47	12.0	24	610	0.012	0.30	7.6	194	1335	300	100/bag
LU126-750	SS316	0.47	12.0	30	750	0.012	0.30	9.4	238	1335	300	100/bag
LU126-1000	SS316	0.47	12.0	39	1000	0.012	0.30	12.5	318	1335	300	100/bag

**Stainless Steel Ladder Type Cable Tie, Coated**

**Technical Information:**

**Material** A) 316 grade non-magnetic stainless steel  
B) 304 grade non-magnetic stainless steel

**Temperature Range** - 80°C to + 150°C

**Surface Finish** Pure Polyester Coating

**Flamability rating** Fireproof Halogen free and UV-resistant



**Ladder-Coated -SS304, 7mm width**

Part No.	Material	Width		Length		Thickness		Max Diameter Single Loop		Minimum Loop Tensile Strength		Package Quantity
		In	mm	In	mm	In	mm	In	mm	N	lbs	
LC74-150	SS304	0.28	7.0	6	150	0.012	0.30	1.9	48	667	150	100/bag
LC74-200	SS304	0.28	7.0	8	200	0.012	0.30	2.5	64	667	150	100/bag
LC74-225	SS304	0.28	7.0	9	225	0.012	0.30	2.8	71	667	150	100/bag
LC74-250	SS304	0.28	7.0	10	250	0.012	0.30	3.1	80	667	150	100/bag
LC74-300	SS304	0.28	7.0	12	300	0.012	0.30	3.8	96	667	150	100/bag
LC74-360	SS304	0.28	7.0	14	360	0.012	0.30	4.5	114	667	150	100/bag
LC74-450	SS304	0.28	7.0	18	450	0.012	0.30	5.6	142	667	150	100/bag
LC74-600	SS304	0.28	7.0	24	600	0.012	0.30	7.5	190	667	150	100/bag
LC74-610	SS304	0.28	7.0	24	610	0.012	0.30	7.6	194	667	150	100/bag
LC74-750	SS304	0.28	7.0	30	750	0.012	0.30	9.4	238	667	150	100/bag
LC74-1000	SS304	0.28	7.0	39	1000	0.012	0.30	12.5	318	667	150	100/bag

**Ladder-Coated -SS316, 7mm width**

Part No.	Material	Width		Length		Thickness		Max Diameter Single Loop		Minimum Loop Tensile Strength		Package Quantity
		In	mm	In	mm	In	mm	In	mm	N	lbs	
LC76-150	SS316	0.28	7.0	6	150	0.012	0.30	1.9	48	667	150	100/bag
LC76-200	SS316	0.28	7.0	8	200	0.012	0.30	2.5	64	667	150	100/bag
LC76-225	SS316	0.28	7.0	9	225	0.012	0.30	2.8	71	667	150	100/bag
LC76-250	SS316	0.28	7.0	10	250	0.012	0.30	3.1	80	667	150	100/bag
LC76-300	SS316	0.28	7.0	12	300	0.012	0.30	3.8	96	667	150	100/bag
LC76-360	SS316	0.28	7.0	14	360	0.012	0.30	4.5	114	667	150	100/bag
LC76-450	SS316	0.28	7.0	18	450	0.012	0.30	5.6	142	667	150	100/bag
LC76-600	SS316	0.28	7.0	24	600	0.012	0.30	7.5	190	667	150	100/bag
LC76-610	SS316	0.28	7.0	24	610	0.012	0.30	7.6	194	667	150	100/bag
LC76-750	SS316	0.28	7.0	30	750	0.012	0.30	9.4	238	667	150	100/bag
LC76-1000	SS316	0.28	7.0	39	1000	0.012	0.30	12.5	318	667	150	100/bag

**Ladder-Coated-SS304, 12mm width**

Part No.	Material	Width		Length		Thickness		Max Diameter Single Loop		Minimum Loop Tensile Strength		Package Quantity
		In	mm	In	mm	In	mm	In	mm	N	lbs	
LC124-150	SS304	0.47	12.0	6	150	0.012	0.30	1.9	48	1335	300	100/bag
LC124-200	SS304	0.47	12.0	8	200	0.012	0.30	2.5	64	1335	300	100/bag
LC124-225	SS304	0.47	12.0	9	225	0.012	0.30	2.8	71	1335	300	100/bag
LC124-250	SS304	0.47	12.0	10	250	0.012	0.30	3.1	80	1335	300	100/bag
LC124-300	SS304	0.47	12.0	12	300	0.012	0.30	3.8	96	1335	300	100/bag
LC124-360	SS304	0.47	12.0	14	360	0.012	0.30	4.5	114	1335	300	100/bag
LC124-450	SS304	0.47	12.0	18	450	0.012	0.30	5.6	142	1335	300	100/bag
LC124-600	SS304	0.47	12.0	24	600	0.012	0.30	7.5	190	1335	300	100/bag
LC124-610	SS304	0.47	12.0	24	610	0.012	0.30	7.6	194	1335	300	100/bag
LC124-750	SS304	0.47	12.0	30	750	0.012	0.30	9.4	238	1335	300	100/bag
LC124-1000	SS304	0.47	12.0	39	1000	0.012	0.30	12.5	318	1335	300	100/bag

**Ladder-Coated-SS316, 12mm width**

Part No.	Material	Width		Length		Thickness		Max Diameter Single Loop		Minimum Loop Tensile Strength		Package Quantity
		In	mm	In	mm	In	mm	In	mm	N	lbs	
LC126-150	SS304	0.47	12.0	6	150	0.012	0.30	1.9	48	1335	300	100/bag
LC126-200	SS304	0.47	12.0	8	200	0.012	0.30	2.5	64	1335	300	100/bag
LC126-225	SS316	0.47	12.0	9	225	0.012	0.30	2.8	71	1335	300	100/bag
LC126-250	SS316	0.47	12.0	10	250	0.012	0.30	3.1	80	1335	300	100/bag
LC126-300	SS316	0.47	12.0	12	300	0.012	0.30	3.8	96	1335	300	100/bag
LC126-360	SS316	0.47	12.0	14	360	0.012	0.30	4.5	114	1335	300	100/bag
LC126-450	SS316	0.47	12.0	18	450	0.012	0.30	5.6	142	1335	300	100/bag
LC126-600	SS316	0.47	12.0	24	600	0.012	0.30	7.5	190	1335	300	100/bag
LC126-610	SS316	0.47	12.0	24	610	0.012	0.30	7.6	194	1335	300	100/bag
LC126-750	SS316	0.47	12.0	30	750	0.012	0.30	9.4	238	1335	300	100/bag
LC126-1000	SS316	0.47	12.0	39	1000	0.012	0.30	12.5	318	1335	300	100/bag



## Stainless Steel Releasable Cable Ties, Uncoated

### Technical Information:

**Releasable Cable Tie** Releasable Type Cable Tie can be used for multiple installations over long period of time

**Material** A) 316 grade non-magnetic stainless steel  
 B) 304 grade non-magnetic stainless steel

**Temperature Range** - 80°C to + 500°C

**Surface Finish** Metallic

**Flamability rating** Absolutely fireproof Halogen Free and UV-resistant

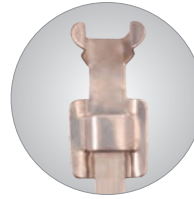

### Releasable-Uncoated-SS304, 6.35mm

Part No.	Material	Width		Length		Thickness		Max Diameter Single Wrap		Minimum Loop Tensile Strength		Package Quantity
		In	mm	In	mm	In	mm	In	mm	N	lbs	
RU64-152	SS304	1/4	6.35	6	152	0.02	0.50	1.5	38	1335	300	100/bag
RU64-229	SS304	1/4	6.35	9	229	0.02	0.50	2.5	63	1335	300	100/bag
RU64-305	SS304	1/4	6.35	12	305	0.02	0.50	3.4	86	1335	300	100/bag
RU64-457	SS304	1/4	6.35	18	457	0.02	0.50	5.4	137	1335	300	100/bag
RU64-610	SS304	1/4	6.35	24	610	0.02	0.50	7.3	185	1335	300	100/bag
RU64-762	SS304	1/4	6.35	30	762	0.02	0.50	9.1	231	1335	300	100/bag
RU64-914	SS304	1/4	6.35	36	914	0.02	0.50	11.0	280	1335	300	100/bag

### Releasable-Uncoated-SS316, 6.35mm

Part No.	Material	Width		Length		Thickness		Max Diameter Single Wrap		Minimum Loop Tensile Strength		Package Quantity
		In	mm	In	mm	In	mm	In	mm	N	lbs	
RU66-152	SS316	1/4	6.35	6	152	0.02	0.50	1.5	38	1335	300	100/bag
RU66-229	SS316	1/4	6.35	9	229	0.02	0.50	2.5	63	1335	300	100/bag
RU66-305	SS316	1/4	6.35	12	305	0.02	0.50	3.4	86	1335	300	100/bag
RU66-457	SS316	1/4	6.35	18	457	0.02	0.50	5.4	137	1335	300	100/bag
RU66-610	SS316	1/4	6.35	24	610	0.02	0.50	7.3	185	1335	300	100/bag
RU66-762	SS316	1/4	6.35	30	762	0.02	0.50	9.1	231	1335	300	100/bag
RU66-914	SS316	1/4	6.35	36	914	0.02	0.50	11.0	280	1335	300	100/bag

### Releasable-Uncoated-SS304, 9.53mm

Part No.	Material	Width		Length		Thickness		Max Diameter Single Loop		Minimum Loop Tensile Strength		Package Quantity
		In	mm	In	mm	In	mm	In	mm	N	lbs	
RU94-152	SS304	3/8	9.53	6	152	0.02	0.50	1.5	38	2003	450	100/bag
RU94-229	SS304	3/8	9.53	9	229	0.02	0.50	2.5	63	2003	450	100/bag
RU94-305	SS304	3/8	9.53	12	305	0.02	0.50	3.4	86	2003	450	100/bag
RU94-457	SS304	3/8	9.53	18	457	0.02	0.50	5.4	137	2003	450	100/bag
RU94-610	SS304	3/8	9.53	24	610	0.02	0.50	7.3	185	2003	450	100/bag
RU94-762	SS304	3/8	9.53	30	762	0.02	0.50	9.1	231	2003	450	100/bag
RU94-914	SS304	3/8	9.53	36	914	0.02	0.50	11.0	280	2003	450	100/bag

### Releasable-Uncoated-SS316, 9.53mm

Part No.	Material	Width		Length		Thickness		Max Diameter Single Loop		Minimum Loop Tensile Strength		Package Quantity
		In	mm	In	mm	In	mm	In	mm	N	lbs	
RU96-152	SS316	3/8	9.53	6	152	0.02	0.50	1.5	38	2003	450	100/bag
RU96-229	SS316	3/8	9.53	9	229	0.02	0.50	2.5	63	2003	450	100/bag
RU96-305	SS316	3/8	9.53	12	305	0.02	0.50	3.4	86	2003	450	100/bag
RU96-457	SS316	3/8	9.53	18	457	0.02	0.50	5.4	137	2003	450	100/bag
RU96-610	SS316	3/8	9.53	24	610	0.02	0.50	7.3	185	2003	450	100/bag
RU96-762	SS316	3/8	9.53	30	762	0.02	0.50	9.1	231	2003	450	100/bag
RU96-914	SS316	3/8	9.53	36	914	0.02	0.50	11.0	280	2003	450	100/bag

## Stainless Steel Releasable Cable Ties, PPA 571 Coated

### Technical Information:

**Releasable Cable Tie** Releasable Type Cable Tie can be used for multiple installations over long period of time

**Material** 316 grade non-magnetic stainless steel

**Temperature Range** - 80°C to + 150°C

**Surface Finish** PPA 571 Coating

**Flamability rating** Fireproof Halogen Free and UV-resistant



### Features

- PPA 571 ES is a thermoplastic coating powder specially designed to provide a long lasting, tough coating for exterior application. PPA 571 is based on an alloy of acid modified polyolefinis.
- Flexible upto - 80°C.
- Resistance to U.V. Weather.
- Resistance to stress cracking on Bending. (Elongation to break upto 800%)
- Excellent resistance to Salt, Sand, Acids, temperature variations & Chemicals
- Halogen Free, Flame retardant & Non-Toxic.
- Provides good abrasion and impact resistance.
- Smooth rounded edges.
- Water Absorption Free.
- Operating Temperature. (- 80°C +150°C).
- Base metal stainless steel AISI 316.

### Releasable-PPA Coated-SS316, 6.35mm

Part No.	Material	Width		Length		Thickness*		Max Diameter Single Loop		Minimum Loop Tensile Strength		Package Quantity
		In	mm	In	mm	In	mm	In	mm	N	lbs	
RC <sub>p</sub> 66-152	SS316	1/4	6.35	6	152	0.043	1.10	1.5	38	1469	330	100/bag
RC <sub>p</sub> 66-229	SS316	1/4	6.35	9	229	0.043	1.10	2.5	63	1469	330	100/bag
RC <sub>p</sub> 66-305	SS316	1/4	6.35	12	305	0.043	1.10	3.4	86	1469	330	100/bag
RC <sub>p</sub> 66-457	SS316	1/4	6.35	18	457	0.043	1.10	5.4	137	1469	330	100/bag
RC 66-610	SS316	1/4	6.35	24	610	0.043	1.10	7.3	185	1469	330	100/bag
RC <sub>p</sub> 66-762	SS316	1/4	6.35	30	762	0.043	1.10	9.1	231	1469	330	100/bag
RC <sub>p</sub> 66-914	SS316	1/4	6.35	36	914	0.043	1.10	11.0	280	1469	330	100/bag

\*Tie thickness includes PPA 571 coating - Base material thickness is 0.5mm (0.02 Inch)

### Releasable-PPA-SS316, 9.53mm

Part No.	Material	Width		Length		Thickness*		Max Diameter Single Loop		Minimum Loop Tensile Strength		Package Quantity
		In	mm	In	mm	In	mm	In	mm	N	lbs	
RC <sub>p</sub> 96-152	SS316	3/8	9.53	6	152	0.043	1.10	1.5	38	2003	450	100/bag
RC <sub>p</sub> 96-229	SS316	3/8	9.53	9	229	0.043	1.10	2.5	63	2003	450	100/bag
RC <sub>p</sub> 96-305	SS316	3/8	9.53	12	305	0.043	1.10	3.4	86	2003	450	100/bag
RC <sub>p</sub> 96-457	SS316	3/8	9.53	18	457	0.043	1.10	5.4	137	2003	450	100/bag
RC <sub>p</sub> 96-610	SS316	3/8	9.53	24	610	0.043	1.10	7.3	185	2003	450	100/bag
RC <sub>p</sub> 96-762	SS316	3/8	9.53	30	762	0.043	1.10	9.1	231	2003	450	100/bag
RC <sub>p</sub> 96-914	SS316	3/8	9.53	36	914	0.043	1.10	11.0	280	2003	450	100/bag

\*Tie thickness includes PPA 571 coating - Base material thickness is 0.5mm (0.02 Inch)

# Bands (Straps) and Buckles (Clips) Systems

## SPECIFICATIONS : STRAPS

**RSU XX A - 506**



RAYCHEM STRAP

Surface Condition	Width, mm	Raw Material	Roll Length, m	Thickness, mm
C : Epoxy Coated	06 - 6.5	A : SS 430	25	4 - 0.4
U : Uncoated	09 - 9.5	B : SS 201	30	5 - 0.5
P : PPA Coated	10 - 10.0	E : SS 316	50	6 - 0.65
VP : PVC Coated	12 - 12.7	F : SS 304	61	7 - 0.7
	16 - 16.0			7-5 - 0.75
	19 - 19.0			
	20 - 20.0			



## Stainless Steel Bands for Corrosive Atmospheric Application

- Superior corrosion resistance in corrosive industrial and marine atmospheres, salt water and chemical environments
- Packed in easy to use plastic tote dispensers, available in 4 colour codes based on band widths. Carton box packing also available
- Application Tools: RR-T03



Part No.	Material	Width		Thickness		Finished Length		Avg. Breaking Strength		Package Quantity
		In	mm	In	mm	Feet	Mtrs	N	lbs	
RSU06E305C	SS316	1/4	6.5	0.020	0.5	100	30.5	1780	400	100'/roll
RSU06E305T	SS316	1/4	6.5	0.020	0.5	100	30.5	1780	400	Red Tote 100'/roll
RSU06E615C	SS316	1/4	6.5	0.020	0.5	200	61.0	1780	400	200'/roll
RSU09E306-5C	SS316	3/8	9.5	0.026	0.65	100	30.5	3338	750	100'/roll
RSU09E306-5T	SS316	3/8	9.5	0.026	0.65	100	30.5	3338	750	Red Tote 100'/roll
RSU09E616-5C	SS316	3/8	9.5	0.026	0.65	200	61.0	3338	750	200'/roll
RSU12E307-5C	SS316	1/2	12.7	0.030	0.75	100	30.5	5340	1200	100'/roll
RSU12E307-5T	SS316	1/2	12.7	0.030	0.75	100	30.5	5340	1200	Yellow Tote 100'/roll
RSU12E617-5C	SS316	1/2	12.7	0.030	0.75	200	61.0	5340	1200	200'/roll
RSU16E307-5C	SS316	5/8	16.0	0.030	0.75	100	30.5	6675	1500	100'/roll
RSU16E307-5T	SS316	5/8	16.0	0.030	0.75	100	30.5	6675	1500	Grey Tote 100'/roll
RSU16E617-5C	SS316	5/8	16.0	0.030	0.75	200	61.0	6675	1500	200'/roll
RSU19E307-5C	SS316	3/4	19.0	0.030	0.75	100	30.5	8010	1800	100'/roll
RSU19E307-5T	SS316	3/4	19.0	0.030	0.75	100	30.5	8010	1800	Blue Tote 100'/roll
RSU19E617-5C	SS316	3/4	19.0	0.030	0.75	200	61.0	8010	1800	200'/roll



Part No.	Material	Width		Thickness		Finished Length		Avg. Breaking Strength		Package Quantity
		In	mm	In	mm	Feet	Mtrs	N	lbs	
RSU06F305C	SS304	1/4	6.5	0.020	0.5	100	30.5	1669	375	100'/roll
RSU06F305T	SS304	1/4	6.5	0.020	0.5	100	30.5	1669	375	Red Tote 100'/roll
RSU06F615C	SS304	1/4	6.5	0.020	0.5	200	61.0	1669	375	200'/roll
RSU09F306-5C	SS304	3/8	9.5	0.026	0.65	100	30.5	3115	700	100'/roll
RSU09F306-5T	SS304	3/8	9.5	0.026	0.65	100	30.5	3115	700	Red Tote 100'/roll
RSU09F616-5C	SS304	3/8	9.5	0.026	0.65	200	61.0	3115	700	200'/roll
RSU12F307-5C	SS304	1/2	12.7	0.030	0.75	100	30.5	4895	1100	100'/roll
RSU12F307-5T	SS304	1/2	12.7	0.030	0.75	100	30.5	4895	1100	Yellow Tote 100'/roll
RSU12F617-5C	SS304	1/2	12.7	0.030	0.75	200	61.0	4895	1100	200'/roll
RSU16F307-5C	SS304	5/8	16.0	0.030	0.75	100	30.5	6230	1400	100'/roll
RSU16F307-5T	SS304	5/8	16.0	0.030	0.75	100	30.5	6230	1400	Grey Tote 100'/roll
RSU16F617-5C	SS304	5/8	16.0	0.030	0.75	200	61.0	6230	1400	200'/roll
RSU19F307-5C	SS304	3/4	19.0	0.030	0.75	100	30.5	7565	1700	100'/roll
RSU19F307-5T	SS304	3/4	19.0	0.030	0.75	100	30.5	7565	1700	Blue Tote 100'/roll
RSU19F617-5C	SS304	3/4	19.0	0.030	0.75	200	61.0	7565	1700	200'/roll



## Stainless Steel Bands for High Tensile Application

- High tensile strength and quality combined with superior finish
- Packed in easy to use plastic tote dispensers, available in 4 colour codes based on band widths & carton box packing also available
- Application Tools: RR-T03



(Under Progress)

## Regular Bands High Tensile Application

Part No.	Material	Width		Thickness		Finished Length		Avg. Breaking Strength		Package Quantity
		In	mm	In	mm	Feet	Mtrs	N	lbs	
RSU06B305C	SS201	1/4	6.5	0.020	0.5	100	30.5	2225	500	100'/roll
RSU06B305T	SS201	1/4	6.5	0.020	0.5	100	30.5	2225	500	Red Tote 100'/roll
RSU06B615C	SS201	1/4	6.5	0.020	0.5	200	61.0	2225	500	200'/roll
RSU09B306-5C	SS201	3/8	9.5	0.026	0.65	100	30.5	4005	900	100'/roll
RSU09B306-5T	SS201	3/8	9.5	0.026	0.65	100	30.5	4005	900	Red Tote 100'/roll
RSU09B616-5C	SS201	3/8	9.5	0.026	0.65	200	61.0	4005	900	200'/roll
RSU12B307-5C	SS201	1/2	12.7	0.030	0.75	100	30.5	6675	1500	100'/roll
RSU12B307-5T	SS201	1/2	12.7	0.030	0.75	100	30.5	6675	1500	Yellow Tote 100'/roll
RSU12B617-5C	SS201	1/2	12.7	0.030	0.75	200	61.0	6675	1500	200'/roll
RSU16B307-5C	SS201	5/8	16.0	0.030	0.75	100	30.5	8344	1875	100'/roll
RSU16B307-5T	SS201	5/8	16.0	0.030	0.75	100	30.5	8344	1875	Grey Tote 100'/roll
RSU16B617-5C	SS201	5/8	16.0	0.030	0.75	200	61.0	8344	1875	200'/roll
RSU19B307-5C	SS201	3/4	19.0	0.030	0.75	100	30.5	10013	2250	100'/roll
RSU19B307-5T	SS201	3/4	19.0	0.030	0.75	100	30.5	10013	2250	Blue Tote 100'/roll
RSU19B617-5C	SS201	3/4	19.0	0.030	0.75	200	61.0	10013	2250	200'/roll



## Regular Bands - Economical Value Application

Part No.	Material	Width		Thickness		Finished Length		Avg. Breaking Strength		Package Quantity
		In	mm	In	mm	Feet	Mtrs	N	lbs	
RSU06A305C	SS430	1/4	6.5	0.020	0.5	100	30.5	1669	375	100'/roll
RSU06A305T	SS430	1/4	6.5	0.020	0.5	100	30.5	1669	375	Red Tote 100'/roll
RSU06A615C	SS430	1/4	6.5	0.020	0.5	200	61.0	1669	375	200'/roll
RSU09A306-5C	SS430	3/8	9.5	0.026	0.65	100	30.5	3115	700	100'/roll
RSU09A306-5T	SS430	3/8	9.5	0.026	0.65	100	30.5	3115	700	Red Tote 100'/roll
RSU09A616-5C	SS430	3/8	9.5	0.026	0.65	200	61.0	3115	700	200'/roll
RSU12A307-5C	SS430	1/2	12.7	0.030	0.75	100	30.5	4895	1100	100'/roll
RSU12A307-5T	SS430	1/2	12.7	0.030	0.75	100	30.5	4895	1100	Yellow Tote 100'/roll
RSU12A617-5C	SS430	1/2	12.7	0.030	0.75	200	61.0	4895	1100	200'/roll
RSU16A307-5C	SS430	5/8	16.0	0.030	0.75	100	30.5	6230	1400	100'/roll
RSU16A307-5T	SS430	5/8	16.0	0.030	0.75	100	30.5	6230	1400	Grey Tote 100'/roll
RSU16A617-5C	SS430	5/8	16.0	0.030	0.75	200	61.0	6230	1400	200'/roll
RSU19A307-5C	SS430	3/4	19.0	0.030	0.75	100	30.5	7565	1700	100'/roll
RSU19A307-5T	SS430	3/4	19.0	0.030	0.75	100	30.5	7565	1700	Blue Tote 100'/roll
RSU19A617-5C	SS430	3/4	19.0	0.030	0.75	200	61.0	7565	1700	200'/roll



## Packing Details

### Band in EASY to USE Plastic Dispenser



Option 1: Easy to Use Plastic Dispenser

### Band in Strong Carton Boxes



Option 2: Strong Corrugated Box

**Utility Bands**

- Specially packed for industrial and utilities requirement
- Bands available in all grades of stainless steel
- Packed in plastic dispensers and Carton Boxes
- Application Tools: RR-T03



(Under Progress)



Part No.	Material	Width		Thickness		Finished Length		Avg. Breaking Strength		Package Quantity
		In	mm	In	mm	Feet	Mtrs	N	lbs	
RSU10B304	SS201	2/5	10.00	0.016	0.40	98.5	30.0	3560	800	30 mtr/ Roll
RSU10B504	SS201	2/5	10.00	0.016	0.40	164	50.0	3560	800	50 mtr/ Roll
RSU10B307	SS201	2/5	10.00	0.028	0.70	98.5	30.0	5340	1200	30 mtr/ Roll
RSU10B507	SS201	2/5	10.00	0.028	0.70	164	50.0	5340	1200	50 mtr/ Roll
RSU20B304	SS201	4/5	20.00	0.016	0.40	98.5	30.0	6675	1500	30 mtr/ Roll
RSU20B504	SS201	4/5	20.00	0.016	0.40	164	50.0	6675	1500	50 mtr/ Roll
RSU20B307	SS201	4/5	20.00	0.028	0.70	98.5	30.0	10235	2300	30 mtr/ Roll
RSU20B507	SS201	4/5	20.00	0.028	0.70	164	50.0	10235	2300	50 mtr/ Roll

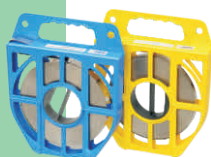

Part No.	Material	Width		Thickness		Finished Length		Avg. Breaking Strength		Package Quantity
		In	mm	In	mm	Feet	Mtrs	N	lbs	
RSU10B304	SS304	2/5	10.00	0.016	0.40	98.5	30.0	2114	475	30 mtr/ Roll
RSU10B504	SS304	2/5	10.00	0.016	0.40	164	50.0	2114	475	50 mtr/ Roll
RSU10B307	SS304	2/5	10.00	0.028	0.70	98.5	30.0	3338	750	30 mtr/ Roll
RSU10B507	SS304	2/5	10.00	0.028	0.70	164	50.0	3338	750	50 mtr/ Roll
RSU20B304	SS304	4/5	20.00	0.016	0.40	98.5	30.0	4450	1000	30 mtr/ Roll
RSU20B504	SS304	4/5	20.00	0.016	0.40	164	50.0	4450	1000	50 mtr/ Roll
RSU20B307	SS304	4/5	20.00	0.028	0.70	98.5	30.0	6675	1500	30 mtr/ Roll
RSU20B507	SS304	4/5	20.00	0.028	0.70	164	50.0	6675	1500	50 mtr/ Roll

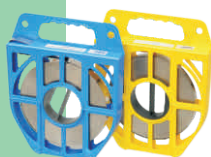

Part No.	Material	Width		Thickness		Finished Length		Avg. Breaking Strength		Package Quantity
		In	mm	In	mm	Feet	Mtrs	N	lbs	
RSU10B304	SS316	2/5	10.00	0.016	0.40	98.5	30.0	2225	500	30 mtr/ Roll
RSU10B504	SS316	2/5	10.00	0.016	0.40	164	50.0	2225	500	50 mtr/ Roll
RSU10B307	SS316	2/5	10.00	0.028	0.70	98.5	30.0	4005	900	30 mtr/ Roll
RSU10B507	SS316	2/5	10.00	0.028	0.70	164	50.0	4005	900	50 mtr/ Roll
RSU20B304	SS316	4/5	20.00	0.016	0.40	98.5	30.0	5340	1200	30 mtr/ Roll
RSU20B504	SS316	4/5	20.00	0.016	0.40	164	50.0	5340	1200	50 mtr/ Roll
RSU20B307	SS316	4/5	20.00	0.028	0.70	98.5	30.0	8010	1800	30 mtr/ Roll
RSU20B507	SS316	4/5	20.00	0.028	0.70	164	50.0	8010	1800	50 mtr/ Roll



Part No.	Material	Width		Thickness		Finished Length		Avg. Breaking Strength		Package Quantity
		In	mm	In	mm	Feet	Mtrs	N	lbs	
RSU10B304	SS430	2/5	10.00	0.016	0.40	98.5	30.0	2114	475	30 mtr/ Roll
RSU10B504	SS430	2/5	10.00	0.016	0.40	164	50.0	2114	475	50 mtr/ Roll
RSU10B307	SS430	2/5	10.00	0.028	0.70	98.5	30.0	3338	750	30 mtr/ Roll
RSU10B507	SS430	2/5	10.00	0.028	0.70	164	50.0	3338	750	50 mtr/ Roll
RSU20B304	SS430	4/5	20.00	0.016	0.40	98.5	30.0	4450	1000	30 mtr/ Roll
RSU20B504	SS430	4/5	20.00	0.016	0.40	164	50.0	4450	1000	50 mtr/ Roll
RSU20B307	SS430	4/5	20.00	0.028	0.70	98.5	30.0	6675	1500	30 mtr/ Roll
RSU20B507	SS430	4/5	20.00	0.028	0.70	164	50.0	6675	1500	50 mtr/ Roll

## Heavy Duty Bands

- Bands for heavy duty industrial applications
- Bands available in all grades of stainless steel
- Packing in carton boxes only



(Under Progress)

Part No.	Material	Width		Thickness		Finished Length		Avg. Breaking Strength		Package Quantity
		In	mm	In	mm	Feet	Mtrs	N	lbs	
RSU19B3011	SS 201	3/4	19.00	0.04	1.10	100	30.5	14685	3300	100'/roll
RSU25B3011	SS 201	1	25.00	0.04	1.10	100	30.5	19580	4400	100'/roll
RSU32B3011	SS 201	1 1/4	32.00	0.04	1.10	100	30.5	24475	5500	100'/roll
RSU19F3011	SS304	3/4	19.00	0.04	1.10	100	30.5	11570	2600	100'/roll
RSU25F3011	SS304	1	25.00	0.04	1.10	100	30.5	15575	3500	100'/roll
RSU32F3011	SS304	1 1/4	32.00	0.04	1.10	100	30.5	19580	4400	100'/roll
RSU19E3011	SS316	3/4	19.00	0.04	1.10	100	30.5	12015	2700	100'/roll
RSU25E3011	SS316	1	25.00	0.04	1.10	100	30.5	16020	3600	100'/roll
RSU32E3011	SS316	1 1/4	32.00	0.04	1.10	100	30.5	20025	4500	100'/roll
RSU19A3011	SS430	3/4	19.00	0.04	1.10	100	30.5	11570	2600	100'/roll
RSU25A3011	SS430	1	25.00	0.04	1.10	100	30.5	15575	3500	100'/roll
RSU32A3011	SS430	1 1/4	32.00	0.04	1.10	100	30.5	19580	4400	100'/roll



## Bands & Buckles Application Process



**1** Pull Buckle on band, ears pointing towards end of band. Form the clamp, holding band on band. Then push the buckle back over the doubled band, bending the end around 1" under the buckle.



**4** Pull on the cutter lever ensuring that the band is cut off at the correct length.



**2** Double wrap the band for a heavier job.



**5** Hold the stub of the band with the thumb and hammer it flat over the bridge of the buckle. Complete the clamp formation by hammering the ears over the stub.



**3** Place the band in the tool, push down on the gripper with the thumb, and tension the clamp by turning the handle. The maximum tension is achieved when the band finally stops moving through the buckle. Once the required tension has been applied, roll the tool over the buckle and simultaneously, reverse the handle carefully through half a turn to avoid snapping or breakage. There is no loss of tension if the handle is reversed very little.



**6** Desired Result as shown above.



**PPA 571 Coated Bands for Highly Corrosive Applications**

- PPA 571 (Performance Polymer Alloy Coating)
- PPA 571 is a thermoplastic coating powder specifically designed to provide a long lasting, tough coating for exterior applications to mild steel, Stainless steel and Aluminum
- PPA 571 is based on an alloy of acid modified Polyolefins. Therefore it is halogen free and the combustion fumes are low in smoke and have a low toxicity index
- Resistant to adverse weather conditions, detergents, salt spray and typical airborne pollutants
- Excellent resistance to stress cracking on bending
- Coating maintains excellent adhesion to the metal substrate without the need for a separate primer. The material also provides good abrasion and impact resistance
- Application : Chemical, Petrochemical, Subsea and Mining Industries



(Under Progress)



Part No.	Material	Width		Thickness		Finished Length		Avg. Breaking Strength		Package Quantity
		In	mm	In	mm	Feet	Mtrs	N	lbs	
RSP06F254C	SS 304	1/4	6.50	0.04	1.10	82.5	25	1490	335	82.5'/roll
RSP06F254T	SS 304	1/4	6.50	0.04	1.10	82.5	25	1490	335	Red Tote 82.5'/roll
RSP09F254C	SS 304	3/8	9.50	0.04	1.10	82.5	25	2250	505	82.5'/roll
RSP09F254T	SS 304	3/8	9.50	0.04	1.10	82.5	25	2250	505	Red Tote 82.5'/roll
RSP12F254C	SS 304	1/2	12.70	0.04	1.10	82.5	25	2980	670	82.5'/roll
RSP12F254T	SS 304	1/2	12.70	0.04	1.10	82.5	25	2980	670	Yellow Tote 82.5'/roll
RSP16F254C	SS 304	5/8	16.00	0.04	1.10	82.5	25	3740	840	82.5'/roll
RSP16F254T	SS 304	5/8	16.00	0.04	1.10	82.5	25	3740	840	Grey Tote 82.5'/roll
RSP19F254C	SS 304	3/4	19.00	0.04	1.10	82.5	25	4450	1000	82.5'/roll
RSP19F254T	SS 304	3/4	19.00	0.04	1.10	82.5	25	4450	1000	Blue Tote 82.5'/roll

Part No.	Material	Width		Thickness		Finished Length		Avg. Breaking Strength		Package Quantity
		In	mm	In	mm	Feet	Mtrs	N	lbs	
RSP06E254C	SS 316	1/4	6.50	0.04	1.10	82.5	25	1490	335	82.5'/roll
RSP06E254T	SS 316	1/4	6.50	0.04	1.10	82.5	25	1490	335	Red Tote 82.5'/roll
RSP09E254C	SS 316	3/8	9.50	0.04	1.10	82.5	25	2250	505	82.5'/roll
RSP09E254T	SS 316	3/8	9.50	0.04	1.10	82.5	25	2250	505	Red Tote 82.5'/roll
RSP12E254C	SS 316	1/2	12.70	0.04	1.10	82.5	25	2980	670	82.5'/roll
RSP12E254T	SS 316	1/2	12.70	0.04	1.10	82.5	25	2980	670	Yellow Tote 82.5'/roll
RSP16E254C	SS 316	5/8	16.00	0.04	1.10	82.5	25	3740	840	82.5'/roll
RSP16E254T	SS 316	5/8	16.00	0.04	1.10	82.5	25	3740	840	Grey Tote 82.5'/roll
RSP19E254C	SS 316	3/4	19.00	0.04	1.10	82.5	25	4450	1000	82.5'/roll
RSP19E254T	SS 316	3/4	19.00	0.04	1.10	82.5	25	4450	1000	Blue Tote 82.5'/roll

**PVC Coated Bands**



- Raychem RPG Ltd. Introduces PVC Coated Stainless Steel Straps From R-Loc.
- A Value for money solution for your coated straps requirements!!
- PVC or Polyvinyl chloride, a thermoplastic polymer has excellent chemical and mechanical properties making it a very effective medium of coating on SS 316.
- Suitable Buckles/Clips and Tools are also supplied as a total solution.
- ABS, Lloyds approved product from the stable of RAYCHEM RPG Ltd.

**R-LOC SS316 PVC COATED BAND RAYCHEM RPG ABS APPROVED**

Part No.	Material	Width		Thickness		Finished Length		Avg. Breaking Strength		Package Quantity
		In	mm	In	mm	Feet	Mtrs	N	lbs	
RSVP12F254	SS 304	1/2	12.70	0.04	1.10	82.5	25	2980	670	82.5'/roll
RSVP16F254	SS 304	5/8	16.00	0.04	1.10	82.5	25	3740	840	82.5'/roll

VPart No.	Material	Width		Thickness		Finished Length		Avg. Breaking Strength		Package Quantity
		In	mm	In	mm	Feet	Mtrs	N	lbs	
RSVP12E254	SS 316	1/2	12.70	0.04	1.10	82.5	25	2980	670	82.5'/roll
RSVP16E254	SS 316	5/8	16.00	0.04	1.10	82.5	25	3740	840	82.5'/roll

**Properties of PPA and PVC Coating**

- Excellent chemical resistance
- Low Moisture Absorption
- Good dimensional stability
- Self extinguishing
- Excellent Bonding strength

**Benefits of PPA and PVC Coating**

- Corrosion Resistance in Harsh Offshore environments
- Excellent for Marine Applications
- Better Cable Bundling through Superior Tensile Strengths
- Unmatched Safety in Oil & Gas carriers and off shore rigs
- Ensures lasting protection from inter metallic corrosion and safeguards the bare metal.



**All Purpose Bands for Easy and Fast Installation**

- Easy to install all Purpose Band
- Perforated band with evenly spaced holes enables fastening with nut & bolt, screw or cable tie
- Uncoated & PPA 571 halogen free coating available



(Under Progress)

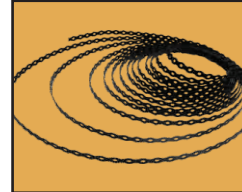

**All Purpose PPA 571 Coated Bands**



Part No.	Material	Width		Thickness		Diameter of Hole		Finished Length		Package Quantity
		In	mm	In	mm	In	mm	Feet	Mtrs	
RSAP12E107-5	SS 316	1/2	12.70	0.04	1.10	3/16	5.00	9.9	3	9.9/roll
RSAP12E107-5	SS 316	1/2	12.70	0.04	1.10	3/16	5.00	33	10	33/roll
RSAP12E257-5	SS 316	1/2	12.70	0.04	1.10	3/16	5.00	82.5	25	82.5/roll
RSAP19E107-5	SS 316	3/4	19.00	0.04	1.10	9/32	7.00	9.9	3	9.9/roll
RSAP19E107-5	SS 316	3/4	19.00	0.04	1.10	9/32	7.00	33	10	33/roll
RSAP19E257-5	SS 316	3/4	19.00	0.04	1.10	9/32	7.00	82.5	25	82.5/roll
RSAP12F107-5	SS 304	1/2	12.70	0.04	1.10	3/16	5.00	9.9	3	9.9/roll
RSAP12F107-5	SS 304	1/2	12.70	0.04	1.10	3/16	5.00	33	10	33/roll
RSAP12F257-5	SS 304	1/2	12.70	0.04	1.10	3/16	5.00	82.5	25	82.5/roll
RSAP19F107-5	SS 304	3/4	19.00	0.04	1.10	9/32	7.00	9.9	3	9.9/roll
RSAP19F107-5	SS 304	3/4	19.00	0.04	1.10	9/32	7.00	33	10	33/roll
RSAP19F257-5	SS 304	3/4	19.00	0.04	1.10	9/32	7.00	82.5	25	82.5/roll
RSAP12G107-5	GCS	1/2	12.70	0.04	1.10	3/16	5.00	9.9	3	9.9/roll
RSAP12G107-5	GCS	1/2	12.70	0.04	1.10	3/16	5.00	33	10	33/roll
RSAP12G257-5	GCS	1/2	12.70	0.04	1.10	3/16	5.00	82.5	25	82.5/roll
RSAP19G107-5	GCS	3/4	19.00	0.04	1.10	9/32	7.00	9.9	3	9.9/roll
RSAP19G107-5	GCS	3/4	19.00	0.04	1.10	9/32	7.00	33	10	33/roll
RSAP19G257-5	GCS	3/4	19.00	0.04	1.10	9/32	7.00	82.5	25	82.5/roll

**All Purpose Uncoated Bands**



Part No.	Material	Width		Thickness		Diameter of Hole		Finished Length		Package Quantity
		In	mm	In	mm	In	mm	Feet	Mtrs	
RSAU12E107-5	SS 316	1/2	12.70	0.03	0.75	3/16	5.00	9.9	3	9.9/roll
RSAU12E107-5	SS 316	1/2	12.70	0.03	0.75	3/16	5.00	33	10	33/roll
RSAU12E257-5	SS 316	1/2	12.70	0.03	0.75	3/16	5.00	82.5	25	82.5/roll
RSAU19E107-5	SS 316	3/4	19.00	0.03	0.75	9/32	7.00	9.9	3	9.9/roll
RSAU19E107-5	SS 316	3/4	19.00	0.03	0.75	9/32	7.00	33	10	33/roll
RSAU19E257-5	SS 316	3/4	19.00	0.03	0.75	9/32	7.00	82.5	25	82.5/roll
RSAU12F107-5	SS 304	1/2	12.70	0.03	0.75	3/16	5.00	9.9	3	9.9/roll
RSAU12F107-5	SS 304	1/2	12.70	0.03	0.75	3/16	5.00	33	10	33/roll
RSAU12F257-5	SS 304	1/2	12.70	0.03	0.75	3/16	5.00	82.5	25	82.5/roll
RSAU19F107-5	SS 304	3/4	19.00	0.03	0.75	9/32	7.00	9.9	3	9.9/roll
RSAU19F107-5	SS 304	3/4	19.00	0.03	0.75	9/32	7.00	33	10	33/roll
RSAU19F257-5	SS 304	3/4	19.00	0.03	0.75	9/32	7.00	82.5	25	82.5/roll
RSAU12G107-5	GCS	1/2	12.70	0.03	0.75	3/16	5.00	9.9	3	9.9/roll
RSAU12G107-5	GCS	1/2	12.70	0.03	0.75	3/16	5.00	33	10	33/roll
RSAU12G257-5	GCS	1/2	12.70	0.03	0.75	3/16	5.00	82.5	25	82.5/roll
RSAU19G107-5	GCS	3/4	19.00	0.03	0.75	9/32	7.00	9.9	3	9.9/roll
RSAU19G107-5	GCS	3/4	19.00	0.03	0.75	9/32	7.00	33	10	33/roll
RSAU19G257-5	GCS	3/4	19.00	0.03	0.75	9/32	7.00	82.5	25	82.5/roll



## Aluminium Perforated Strip for Easy and Fast Installation

- Easy to install Aluminium Perforated Band for light duty applications
- Perforated band with evenly spaced holes & slots enables fastening with nut & bolt, screw or cable tie
- Uncoated & Polyester colour coated bands available

Part No.	Material	Coating Colour	Width		Thickness		Diameter of Hole		Finished Length		Package Quantity
			In	mm	In	mm	In	mm	Feet	Mtrs	
RSAB19AI-10-O	Aluminium	Orange	0.75	19	0.047	1.2	0.28	7	33	10	33'/roll
RSAB19AI-25-O	Aluminium	Orange	0.75	19	0.047	1.2	0.28	7	82.5	25	82.5'/roll
RSAB19AI-10-G	Aluminium	Grey	0.75	19	0.047	1.2	0.28	7	33	10	33'/roll
RSAB19AI-25-G	Aluminium	Grey	0.75	19	0.047	1.2	0.28	7	82.5	25	82.5'/roll

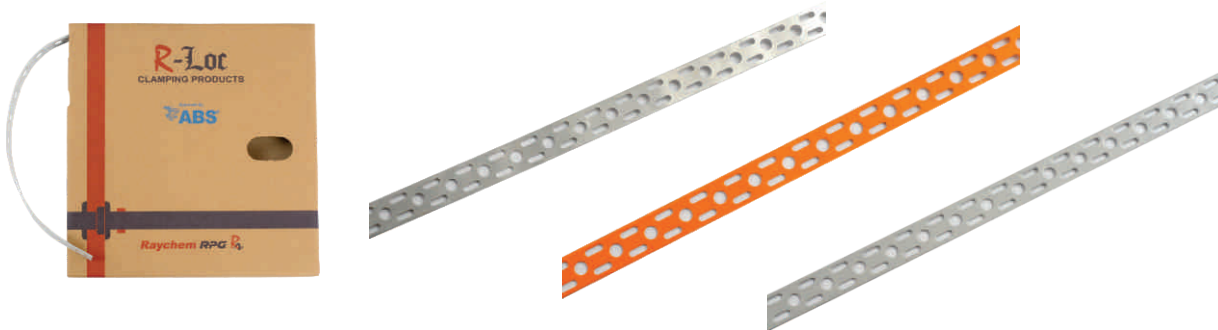

## Tools

### RR-G01 Cable Tie Automatic Gun.

- Easy to install automatic gun, with single hand operation.
- Cable tie side entry for immediate positioning of tie & tool.
- Controlled tension & fully adjustable to achieve desired tension.
- Easy and automatic removal of excess tie length with auto cut-off.



### RR-P02 Cable Tensioning Plier.

- Hand operated tool with installer controlled tension and cut-off.
- Cable tie side entry for immediate positioning of tie & tool.
- Easy removal of excess tie length. Lever actuated cut-off.
- Rugged, lightweight, easy to operate Plier type tool provides mechanical advantage



### RR-T03 Band and Buckle Crimping Tool.

- Band & Buckle Crimping tool features a spring-loaded gripper lever for more efficient strap handling.
- Cut-off handle is vinyl coated for easier operation.
- Standard Blue coating finish provides superior corrosion resistance and enhances life.



### Other Tools Available

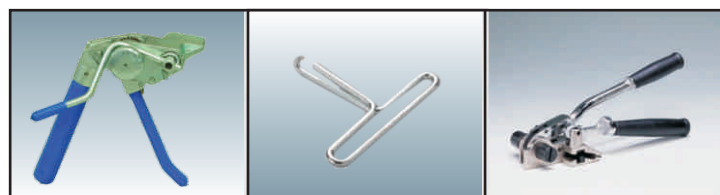

RR-B04 (Bantam Tool)

RR-H05 (Cable Tie Hook)

RR-R06 (Ratchet Tool)

**Buckles - Jaw Type**

**Uncoated Buckles**

Part No.	Material	Width		Package Quantity
		In	mm	
RCU06BJ	SS201	1/4	6.5	100/box
RCU09BJ	SS201	3/8	9.5	100/box
RCU10BJ	SS201	2/5	10	100/box
RCU12BJ	SS201	1/2	12.7	100/box
RCU16BJ	SS201	5/8	16	100/box
RCU19BJ	SS201	3/4	19	100/box
RCU20BJ	SS201	4/5	20	100/box

Part No.	Material	Width		Package Quantity
		In	mm	
RCU06FJ	SS304	1/4	6.5	100/box
RCU09FJ	SS304	3/8	9.5	100/box
RCU10FJ	SS304	2/5	10	100/box
RCU12FJ	SS304	1/2	12.7	100/box
RCU16FJ	SS304	5/8	16	100/box
RCU19FJ	SS304	3/4	19	100/box
RCU20FJ	SS304	4/5	20	100/box

Part No.	Material	Width		Package Quantity
		In	mm	
RCU06EJ	SS316	1/4	6.5	100/box
RCU09EJ	SS316	3/8	9.5	100/box
RCU10EJ	SS316	2/5	10	100/box
RCU12EJ	SS316	1/2	12.7	100/box
RCU16EJ	SS316	5/8	16	100/box
RCU19EJ	SS316	3/4	19	100/box
RCU20EJ	SS316	4/5	20	100/box

**Coated Buckles**

Part No.	Material	Width		Package Quantity
		In	mm	
RCC06BJ	SS201	1/4	6.5	100/box
RCC09BJ	SS201	3/8	9.5	100/box
RCC10BJ	SS201	2/5	10	100/box
RCC12BJ	SS201	1/2	12.7	100/box
RCC16BJ	SS201	5/8	16	100/box
RCC19BJ	SS201	3/4	19	100/box
RCC20BJ	SS201	4/5	20	100/box

Part No.	Material	Width		Package Quantity
		In	mm	
RCC06FJ	SS304	1/4	6.5	100/box
RCC09FJ	SS304	3/8	9.5	100/box
RCC10FJ	SS304	2/5	10	100/box
RCC12FJ	SS304	1/2	12.7	100/box
RCC16FJ	SS304	5/8	16	100/box
RCC19FJ	SS304	3/4	19	100/box
RCC20FJ	SS304	4/5	20	100/box

Part No.	Material	Width		Package Quantity
		In	mm	
RCC06EJ	SS316	1/4	6.5	100/box
RCC09EJ	SS316	3/8	9.5	100/box
RCC10EJ	SS316	2/5	10	100/box
RCC12EJ	SS316	1/2	12.7	100/box
RCC16EJ	SS316	5/8	16	100/box
RCC19EJ	SS316	3/4	19	100/box
RCC20EJ	SS316	4/5	20	100/box

**Buckles - Wing Type**

**Uncoated Buckles**

Part No.	Material	Width		Package Quantity
		In	mm	
RCU06BW	SS201	1/4	6.5	100/box
RCU09BW	SS201	3/8	9.5	100/box
RCU10BW	SS201	2/5	10	100/box
RCU12BW	SS201	1/2	12.7	100/box
RCU16BW	SS201	5/8	16	100/box
RCU19BW	SS201	3/4	19	100/box
RCU20BW	SS201	4/5	20	100/box

Part No.	Material	Width		Package Quantity
		In	mm	
RCU06FW	SS304	1/4	6.5	100/box
RCU09FW	SS304	3/8	9.5	100/box
RCU10FW	SS304	2/5	10	100/box
RCU12FW	SS304	1/2	12.7	100/box
RCU16FW	SS304	5/8	16	100/box
RCU19FW	SS304	3/4	19	100/box
RCU20FW	SS304	4/5	20	100/box

Part No.	Material	Width		Package Quantity
		In	mm	
RCU06EW	SS316	1/4	6.5	100/box
RCU09EW	SS316	3/8	9.5	100/box
RCU10EW	SS316	2/5	10	100/box
RCU12EW	SS316	1/2	12.7	100/box
RCU16EW	SS316	5/8	16	100/box
RCU19EW	SS316	3/4	19	100/box
RCU20EW	SS316	4/5	20	100/box

**Coated Buckles**

Part No.	Material	Width		Package Quantity
		In	mm	
RCC06BW	SS201	1/4	6.5	100/box
RCC09BW	SS201	3/8	9.5	100/box
RCC10BW	SS201	2/5	10	100/box
RCC12BW	SS201	1/2	12.7	100/box
RCC16BW	SS201	5/8	16	100/box
RCC19BW	SS201	3/4	19	100/box
RCC20BW	SS201	4/5	20	100/box

Part No.	Material	Width		Package Quantity
		In	mm	
RCC06FW	SS304	1/4	6.5	100/box
RCC09FW	SS304	3/8	9.5	100/box
RCC10FW	SS304	2/5	10	100/box
RCC12FW	SS304	1/2	12.7	100/box
RCC16FW	SS304	5/8	16	100/box
RCC19FW	SS304	3/4	19	100/box
RCC20FW	SS304	4/5	20	100/box

Part No.	Material	Width		Package Quantity
		In	mm	
RCC06EW	SS316	1/4	6.5	100/box
RCC09EW	SS316	3/8	9.5	100/box
RCC10EW	SS316	2/5	10	100/box
RCC12EW	SS316	1/2	12.7	100/box
RCC16EW	SS316	5/8	16	100/box
RCC19EW	SS316	3/4	19	100/box
RCC20EW	SS316	4/5	20	100/box

**Buckles - Screw Type**

Part No.	Material	Width		Package Quantity
		In	mm	
RCU06BS	SS201	1/4	6.5	100/box
RCU09BS	SS201	3/8	9.5	100/box
RCU10BS	SS201	2/5	10	100/box
RCU12BS	SS201	1/2	12.7	100/box
RCU16BS	SS201	5/8	16	100/box
RCU19BS	SS201	3/4	19	100/box
RCU20BS	SS201	4/5	20	100/box



Part No.	Material	Width		Package Quantity
		In	mm	
RCU06FS	SS304	1/4	6.5	100/box
RCU09FS	SS304	3/8	9.5	100/box
RCU10FS	SS304	2/5	10	100/box
RCU12FS	SS304	1/2	12.7	100/box
RCU16FS	SS304	5/8	16	100/box
RCU19FS	SS304	3/4	19	100/box
RCU20FS	SS304	4/5	20	100/box

Part No.	Material	Width		Package Quantity
		In	mm	
RCU06ES	SS316	1/4	6.5	100/box
RCU09ES	SS316	3/8	9.5	100/box
RCU10ES	SS316	2/5	10	100/box
RCU12ES	SS316	1/2	12.7	100/box
RCU16ES	SS316	5/8	16	100/box
RCU19ES	SS316	3/4	19	100/box
RCU20ES	SS316	4/5	20	100/box

**Sign Mounting Brackets**

- Sign Mounts are used to mount traffic signs, junction boxes, enclosures and various other objects
- Withstands stress & vibrations as mounts are made from high tensile SS steel.
- Bolts are specially made from corrosion resistant SS304 grade and standard size.
- Metal & fibre washer provided to absorb vibrations and better clamping.

Product Code	Description	Material Grade	Slot Size		Leg Type	Package Quantity	Image
			mm	Inch			

**Mini Single Bolt Bracket**

RM12MS	Straight Leg Mini Bracket SS201, 1/2" slot only.	SS201	12.7	1/2	Straight	50/box	
RM12MSA	Straight Leg Mini Bracket SS201, 1/2" slot with SS Bolt and Washer	SS201	12.7	1/2	Straight	50/box	
RM12MF	Flared Leg Mini Bracket SS201, 1/2" slot only.	SS201	12.7	1/2	Flared	50/box	
RM12MFA	Flared Leg Mini Bracket SS201, 1/2" slot with SS Bolt and Washer	SS201	12.7	1/2	Flared	50/box	

**Regular Single Bolt Bracket**

RM19SS	Straight Leg Single Bolt Bracket SS201, 3/4" slot only.	SS201	19	3/4	Straight	50/box	
RM19SSA	Straight Leg Single Bolt Bracket SS201, 3/4" slot with SS Bolt and Washer	SS201	19	3/4	Straight	50/box	
RM19SF	Flared Leg Single Bolt Bracket SS201, 3/4" slot only.	SS201	19	3/4	Flared	50/box	
RM19SFA	Flared Leg Single Bolt Bracket SS201, 3/4" slot with SS Bolt and Washer	SS201	19	3/4	Flared	50/box	

**Two Bolt Bracket**

RM19TS	Straight Leg Two Bolt Bracket SS201, 3/4" slot only.	SS201	19	3/4	Straight	50/box	
RM19TSA	Straight Leg Two Bolt Bracket SS201, 3/4" slot with SS Bolt and Washer	SS201	19	3/4	Straight	50/box	



# Pre-Cut Band and Buckle System

## Center Punch Preformed clamps

- Used in less demanding applications where minimizing leaks and longevity are not critical
- Lock with impact from a hammer using a conical punch
- Double wrapped using Stainless Steel strap
- Manufactured with thicker Stainless Steel buckles
- Not recommended for use with fittings that may crack as a result of impact

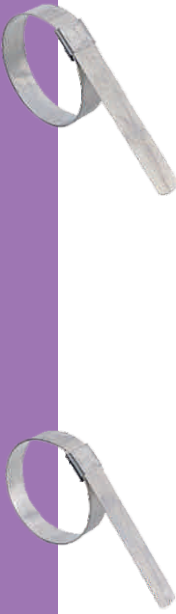

Part Nos. & Stainless Steel Grade			Width		Thickness		Inside Diameter		Package Quantity
SS201	SS304	SS316	In	mm	In	mm	In	mm	
RCPB1020	RCPF1020	RCPE1020	2/5	10.0	0.026	0.65	13/16	20	100/box
RCPB1035	RCPF1035	RCPE1035	2/5	10.0	0.026	0.65	1 3/8	35	100/box
RCPB1625	RCPF1625	RCPE1625	5/8	16.0	0.026	0.65	1	25	100/box
RCPB1632	RCPF1632	RCPE1632	5/8	16.0	0.026	0.65	1 1/4	32	100/box
RCPB1638	RCPF1638	RCPE1638	5/8	16.0	0.026	0.65	1 1/2	38	100/box
RCPB1644	RCPF1644	RCPE1644	5/8	16.0	0.026	0.65	1 3/4	44	100/box
RCPB1651	RCPF1651	RCPE1651	5/8	16.0	0.026	0.65	2	51	100/box
RCPB1657	RCPF1657	RCPE1657	5/8	16.0	0.026	0.65	2 1/4	57	100/box
RCPB1664	RCPF1664	RCPE1664	5/8	16.0	0.026	0.65	2 1/2	64	50/box
RCPB1670	RCPF1670	RCPE1670	5/8	16.0	0.026	0.65	2 3/4	70	50/box
RCPB1676	RCPF1676	RCPE1676	5/8	16.0	0.026	0.65	3	76	50/box
RCPB1689	RCPF1689	RCPE1689	5/8	16.0	0.026	0.65	3 1/2	89	50/box
RCPB16102	RCPF16102	RCPE16102	5/8	16.0	0.026	0.65	4	102	25/box
RCPB16114	RCPF16114	RCPE16114	5/8	16.0	0.026	0.65	4 1/2	114	25/box
RCPB16127	RCPF16127	RCPE16127	5/8	16.0	0.026	0.65	5	127	25/box
RCPB16152	RCPF16152	RCPE16152	5/8	16.0	0.026	0.65	6	152	25/box
RCPB16165	RCPF16165	RCPE16165	5/8	16.0	0.026	0.65	6 1/2	165	25/box
RCPB16178	RCPF16178	RCPE16178	5/8	16.0	0.026	0.65	7	178	25/box
RCPB16203	RCPF16203	RCPE16203	5/8	16.0	0.026	0.65	8	203	25/box

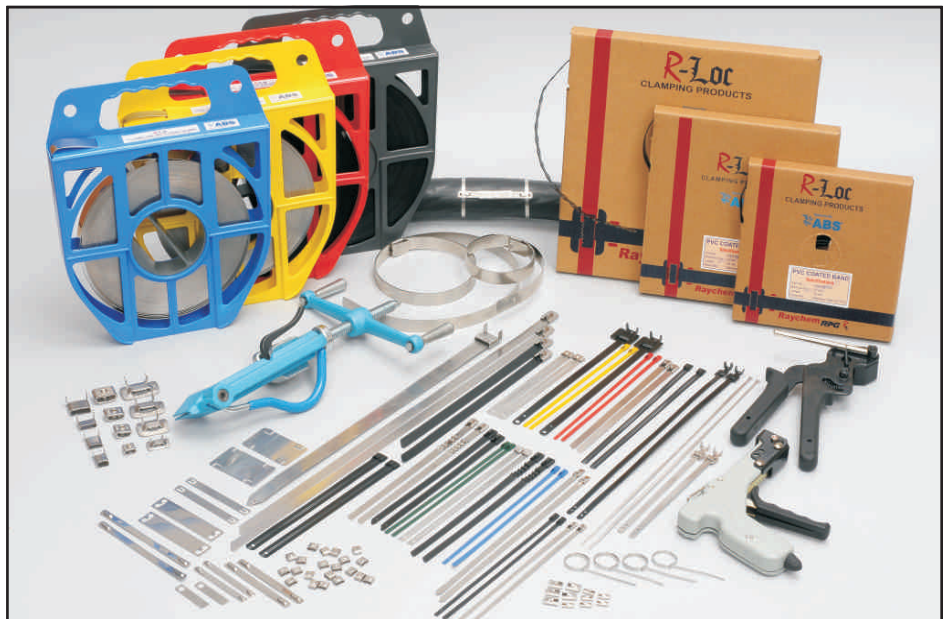

## Precut Assembled Straps

- Ready to use pre-cut band, assembled with buckles, Jaw or Wing type.
- Time saving & cost effective solution for large projects.
- Standard length & loop diameters available allowing fast installation and less scrap material.
- Available in high tensile SS201 as standard range, SS304, SS316 & SS430 can be offered on request.

## Jaw type Precut Strap

Part No.	Material	Width*		Thickness		Finished Length		Maximum Diameter				Package Quantity
		In	mm	In	mm	In	mm	Single Wrap		Double Wrap		
								In	mm	In	mm	
PJ12A207	SS201	1/2	12.7	0.030	0.76	20	51	4	102	2	51	25/box
PJ12A247	SS201	1/2	12.7	0.030	0.76	24	61	5	127	2 1/2	64	25/box
PJ12A277	SS201	1/2	12.7	0.030	0.76	27	69	6	152	3	76	25/box
PJ12A347	SS201	1/2	12.7	0.030	0.76	34	86	8	203	4	102	25/box
PJ12A417	SS201	1/2	12.7	0.030	0.76	41	104	10	254	5	127	25/box
PJ12A487	SS201	1/2	12.7	0.030	0.76	48	122	12	305	6	152	25/box
PJ12A557	SS201	1/2	12.7	0.030	0.76	55	140	14	356	7	178	25/box
PJ12A697	SS201	1/2	12.7	0.030	0.76	69	175	18	457	9	229	25/box
PJ12A767	SS201	1/2	12.7	0.030	0.76	76	193	20	508	10	254	25/box
PJ12A907	SS201	1/2	12.7	0.030	0.76	90	229	24	610	12	305	25/box
PJ19A207	SS201	3/4	19	0.030	0.76	20	51	4	102	2	51	25/box
PJ19A247	SS201	3/4	19	0.030	0.76	24	61	5	127	2 1/2	64	25/box
PJ19A277	SS201	3/4	19	0.030	0.76	27	69	6	152	3	76	25/box
PJ19A347	SS201	3/4	19	0.030	0.76	34	86	8	203	4	102	25/box
PJ19A417	SS201	3/4	19	0.030	0.76	41	104	10	254	5	127	25/box
PJ19A487	SS201	3/4	19	0.030	0.76	48	122	12	305	6	152	25/box
PJ19A557	SS201	3/4	19	0.030	0.76	55	140	14	356	7	178	25/box
PJ19A697	SS201	3/4	19	0.030	0.76	69	175	18	457	9	229	25/box
PJ19A767	SS201	3/4	19	0.030	0.76	76	193	20	508	10	254	25/box
PJ19A907	SS201	3/4	19	0.030	0.76	90	229	24	610	12	305	25/box

\*Jaw type Precut straps also available in 9.5mm and 16mm widths on request

## Wing type Precut Strap

Part No.	Material	Width		Thickness		Finished Length		Maximum Diameter				Package Quantity
		In	mm	In	mm	In	mm	Single Wrap		Double Wrap		
								In	mm	In	mm	
PW06A105	SS201	1/4	6.5	0.020	0.5	10	25	2	50	Not Suggested		50/box
PW06A165	SS201	1/4	6.5	0.020	0.5	16	40	3 1/2	88	1 1/2	38	50/box
PW06A195	SS201	1/4	6.5	0.020	0.5	19	48	5	127	2 1/2	63	50/box
PW06A265	SS201	1/4	6.5	0.020	0.5	26	68	7	177	3 1/2	88	50/box
PW06A345	SS201	1/4	6.5	0.020	0.5	34	86	9	228	4 1/2	114	50/box
PW09A166	SS201	3/8	9.5	0.026	0.65	16	40	3 1/2	88	1 1/2	38	50/box
PW09A446	SS201	3/8	9.5	0.026	0.65	44	112	12	305	6	152	50/box
PW12A187	SS201	1/2	12.7	0.030	0.76	18	45	4	102	2	50	50/box
PW12A317	SS201	1/2	12.7	0.030	0.76	31	78	8	203	4	101	50/box
PW16A217	SS201	5/8	16	0.030	0.76	21	53	5	127	2 1/2	63	50/box
PW16A567	SS201	5/8	16	0.030	0.76	56	142	16	406	8	203	50/box
PW16A697	SS201	5/8	16	0.030	0.76	69	508	20	508	10	175	50/box
PW19A247	SS201	3/4	19	0.030	0.76	24	60	6	152	3	76	50/box
PW19A377	SS201	3/4	19	0.030	0.76	37	93	10	254	5	127	50/box
PW19A507	SS201	3/4	19	0.030	0.76	50	127	14	355	7	177	50/box
PW19A627	SS201	3/4	19	0.030	0.76	62	157	18	457	9	228	50/box



# Identification System

## R- Loc Alpha Numeric Characters (Marker Tags)

Part No	Description	Material Grade	Package Quantity
RT A	R-Loc Tag A	SS316	100/bag
RT B	R-Loc Tag B	SS316	100/bag
RT C	R-Loc Tag C	SS316	100/bag
RT D	R-Loc Tag D	SS316	100/bag
RT E	R-Loc Tag E	SS316	100/bag
RT F	R-Loc Tag F	SS316	100/bag
RT G	R-Loc Tag G	SS316	100/bag
RT H	R-Loc Tag H	SS316	100/bag
RT I	R-Loc Tag I	SS316	100/bag
RT J	R-Loc Tag J	SS316	100/bag
RT K	R-Loc Tag K	SS316	100/bag
RT L	R-Loc Tag L	SS316	100/bag
RT M	R-Loc Tag M	SS316	100/bag
RT N	R-Loc Tag N	SS316	100/bag
RT O	R-Loc Tag O	SS316	100/bag
RT P	R-Loc Tag P	SS316	100/bag
RT Q	R-Loc Tag Q	SS316	100/bag
RT R	R-Loc Tag R	SS316	100/bag
RT S	R-Loc Tag S	SS316	100/bag
RT T	R-Loc Tag T	SS316	100/bag
RT U	R-Loc Tag U	SS316	100/bag
RT V	R-Loc Tag V	SS316	100/bag
RT W	R-Loc Tag W	SS316	100/bag
RT X	R-Loc Tag X	SS316	100/bag
RT Y	R-Loc Tag Y	SS316	100/bag
RT Z	R-Loc Tag Z	SS316	100/bag
RT 1	R-Loc Tag 1	SS316	100/bag
RT 2	R-Loc Tag 2	SS316	100/bag
RT 3	R-Loc Tag 3	SS316	100/bag
RT 4	R-Loc Tag 4	SS316	100/bag
RT 5	R-Loc Tag 5	SS316	100/bag
RT 6	R-Loc Tag 6	SS316	100/bag
RT 7	R-Loc Tag 7	SS316	100/bag
RT 8	R-Loc Tag 8	SS316	100/bag
RT 9	R-Loc Tag 9	SS316	100/bag
RT 0	R-Loc Tag 0	SS316	100/bag
RT	R-Loc Tag Blank	SS316	100/bag
RT +	R-Loc Tag Plus +	SS316	100/bag
RT -	R-Loc Tag Minus	SS316	100/bag
RT ~	R-Loc Tag Sine ~	SS316	100/bag
RT ->	R-Loc Tag Arrow ->	SS316	100/bag
RT /	R-Loc Tag Slash /	SS316	100/bag
RT &	R-Loc Tag And &	SS316	100/bag
RT ±	R-Loc Tag Earth ±	SS316	100/bag

- 316 Stainless Steel.
- Easy to read in dim light and inaccessible places.
- Complete range of individual letters, numbers, and symbols.
- CARRIERS are fastened with a variety of R-Loc cable ties.
- Slide directly onto cable ties to create a self-contained wrap tag.
- CARRIER STRIPS are used to create your own carrier in multiple colors for identification.



Marker Tags Installed on Power Cable



Marker Tags with SS Cable Ties



Marker Tags on Carrier Strips



Carrier Strips



Coated Carrier Strips

## Carrier Strips - Uncoated

Product Code	Material Grade	Length		Width		Package Quantity
		mm	Inch	mm	Inch	
ID6	SS316	92.5	3 2/3	8	1/3	100/Box
ID10	SS316	130.6	5 1/7	8	1/3	100/Box
ID16	SS316	187.7	7 2/5	8	1/3	100/Box



## Carrier Strips - Coated

Product Code	Material Grade	Length		Width		Package Quantity
		mm	Inch	mm	Inch	
IDC6	SS316	92.5	3 2/3	10	2/5	100/Box
IDC10	SS316	130.6	5 1/7	10	2/5	100/Box
IDC16	SS316	187.7	7 2/5	10	2/5	100/Box



## R-Loc Marker Plates & Tags

- Identify pipes, conduit, valves, cables and equipment in petrochemical plants, pulp and paper mills, refineries, offshore oil rigs and in any other harsh environments
- All marker plates/tags can be custom marked by R-Loc with one of two computer controlled systems (laser or embosser) to provide permanent identification to resist corrosion, abrasion and radiation
- Use with R-Loc Standard and Heavy duty Stainless Steel ties.

Product Code	Material Grade	Length		Width		Package Quantity	Product Image
		mm	Inch	mm	Inch		
T7407	SS316	74	3	7	2/7	100/Box	
T8909	SS316	89	3 1/2	9.5	3/8	100/Box	
T5019	SS316	50	2	19	3/4	100/Box	
T8919	SS316	89	3 1/2	19	3/4	100/Box	
T6338	SS316	63	2 1/2	38	1 1/2	100/Box	





## R-Loc Custom Marked Tags

### Laser Marking System

- Used on all stainless steel cable ties, strapping, metal marker plates/tags
- BOLD block letters
- Upper and lower case character capability.
- Alphanumeric and sequential numbering ability.

### Embossing System

- Used on metal marker plates and tags which are a maximum of 0.5 mm thick
- Excellent for application that are exposed to occasional painting and excessive dirt
- Upper case “raised” character capability only.
- Alphanumeric and sequential numbering ability.

Product Code*	Material Grade	Length		Width		Package Quantity	Product Image	Metal Embossing / Laser Etching Details
		mm	Inch	mm	Inch			
T7407	SS316	74	3	7	2/7	100/Box		Single Line - Multiple Characters Laser Etching & (No Embossing)
T8909	SS316	89	3 1/2	9.5	3/8	100/Box		Single Line - Multiple Characters Character Height Option - 3mm & 4mm Laser Etching & Embossing Available
T5019	SS316	50	2	19	3/4	100/Box		Three Lines - Multiple Characters Character Height Option - 3mm & 4mm Laser Etching & Embossing Available
T8919	SS316	89	3 1/2	19	3/4	100/Box		Three Lines - Multiple Characters Character Height Option - 3mm & 4mm Laser Etching & Embossing Available
T6338	SS316	63	2 1/2	38	1 1/2	100/Box		Five Lines - Multiple Characters Character Height Option - 3mm & 4mm Laser Etching & Embossing Available

\*Suffix “L” for Laser and “E” for Emboss

## Quality Systems & Type Approvals







- UL** : “R-Loc” Raychem RPG Clamping products have Underwriters Laboratories Listing on the products indicated.
- DNV** : “R-Loc” Raychem RPG Pvt. Ltd. has Det Norske Veritas Type Approval on the products indicated.
- ABS** : “R-Loc” Raychem RPG Pvt. Ltd. Stainless Steel Coated & Uncoated Bands & Buckles have ABS Class Type Approval on products indicated.
- Lloyds** : “R-Loc” Raychem RPG Pvt. Ltd. Clamping products have Lloyds Register for Shipping Class Type Approval on products indicated.
- ROHS** : All Bands & Buckles, Clamps, Cable Ties & other products that are manufactured at Raychem RPG Pvt. Ltd. are fully compliant within the EU ROHS directive and has no hazardous substances & heavy metals.
- ISO9001:2000** : All “R-Loc” Raychem RPG Pvt. Ltd. products are manufactured in an ISO9001 certified manufacturing set-ups with adherence to international quality management standards.
- ISO14001:2002** : “R-Loc” Raychem RPG Pvt. Ltd. products are manufactured in an Environment Friendly ISO14001 certified plant.



### Rigorous Tests & Physical properties of Stainless Steel Clamping Products.

- Tensile Strength** : Stainless Steel Ties are tested for Tensile strength on specially designed fixture on tensile testing machine.
- Material Grade** : Ties are 100% Stainless Steel (Locking Head, Locking Ball & Body all provided in same grade of material ordered). Spectrometer lab analysis of stainless steel raw material is mandatory at Raychem RPG to ensure quality of stainless steel grades.
- Extreme Temperature** : Stainless Steel clamping products are tested on temperature extremes and withstand from -80 C to 500 C without any signs of cracks, distortions, breaks, release of locking devise & meet minimum tensile requirements.
- Salt Spray** : Stainless Steel Ties have been subjected to salt spray tests without any signs of Corrosion or reduction in Performance.
- Outdoor UV Exposure** : Stainless Steel clamping products remain unaffected in long UV exposure in outdoor atmospheres.

### Laboratory Testing facilities for R-Loc Clamping products

<p><b>SPECTROMETER</b></p>  <p>Used for checking the chemical composition of the metal</p>	<p><b>DIGITAL FILM THICKNESS CHECKER</b></p>  <p>This Instrument is used for Checking Powder Coating Thickness on Coated Cable Ties.</p>	<p><b>VISION MEASUREMENT SYSTEM</b></p>  <p>Used for Checking Profile Dimensions of Buckle.</p>	<p><b>CMM MACHINE</b></p>  <p>CMM Machine is used for Checking Critical Dimensions.</p>
<p><b>TENSILE TESTING MACHINE</b></p>  <p>Tensile Testing Machine for Testing Raw Material &amp; Mechanical Properties</p>	<p><b>LOAD TESTING USING TENSILE TESTING MACHINE</b></p>  <p>Cable Ties are Fit into the Specially Designed Fixture, then it is Put for Load Testing</p>	<p><b>SURFACE TESTING MACHINE</b></p>  <p>Machine is used for Checking Surface Roughness of Components.</p>	

**Stress - Strain Curve for Typical Tensile Test**

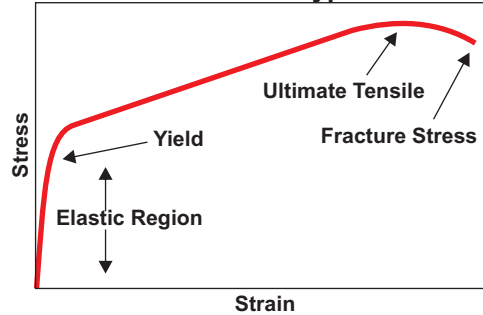

AISI Type Number		SS 430	SS 201	SS 304	SS 316
<b>Specification - Equivalents</b>	UNS	S4300	S20100	S30400	S31600
	BS	430S17	301S21	304S31	316S31
	Euronorm	W. No: 1.4016 Name: X8 Cr17	W. No: 1.4310 Name: X10CrNi18-8	W. No: 1.4301 Name: X5CrNi18-10	W.No: 1.4401 Name: X5CrNiMo17-12-2
	Swedish	SS2320	SS2331	SS2332	SS2347
	JIS	SUS430	SUS201	SUS304	SUS316
<b>Composition</b>	Carbon - % C	0.12 Max	0.15 Max	0.07 Max	0.08 Max
	Manganese - % Mn	1.00 Max	5.5 - 7.5	2.00 Max	2.00 Max
	Phosphorous - % P	0.04 Max	0.06 Max	0.045 Max	0.045 Max
	Silicon - % Si	1.00 Max	1.00 Max	0.75 Max	0.75 Max
	Sulphur - S	0.03 Max	0.03 Max	0.03 Max	0.03 Max
	Chromium - % Cr	16.00 - 18.00	16.00 - 18.00	17.50 - 19.50	16.0 - 18.0
	Nickel - % Ni	0.75 Min	3.50 - 5.50	8.0 - 10.50	10.0 - 14.0
	Nitrogen - % N		0.25 Max	0.10 Max	0.10 Max
Molybdenum - % Mo				2.00 - 3.00	
<b>Physical Properties</b>					
Molecular Structure		Ferritic	Austenitic	Austenitic	Austenitic
Density (Kilogram per Cubic Centimetre)		7750	7800	8000	8000
Modulus of elasticity (Giga Pascal)		200	197	193	193
Mean Coefficient of Thermal Expansion	0 - 100 Degree Celcius	10.4	15.7	17.2	15.9
	0 - 315 Degree Celcius	11	17.5	17.8	16.2
	0 - 538 Degree Celcius	11.4	18.4	18.4	17.5
<b>Electrical Properties</b>					
Magnetism		Magnetic	Non-Magnetic	Non-Magnetic	Non-Magnetic
Electrical Resistivity (NanoOhm Metre)		600	690	720	740
<b>Mechanical Properties</b>					
Ultimate Tensile Strength(Min)	Mega Pascal(Mpa)	450	515	515	515
Yield Strength(Min)	Mega Pascal(Mpa)	205	260	205	205
Elongation (% min)	in 50mm,	22	40	40	40
Hardness, Max	Rockwell B	183	217	201	217
	Brinell	89	95	92	95
<b>Corrosive Properties</b>					
Moderate Environments		Good Resistance	Good Resistance	Very Good Resistance	Excellent Resistance
Marine& Offshore Environments		Poor Resistance	Fair Resistance	Good Resistance	Very Good Resistance
Oxidising Environments		Fair Resistance	Fair Resistance	Fair Resistance	Very Good Resistance
Reducing Environments		Not Recommended for use	Not Recommended for use	Not Recommended for use	Good Resistance
<b>Applications</b>		Economic Bands & Buckles	Extra strong Bands & Buckles for construction and automotive	Bands & Buckles,Economical Cable Ties,Outdoor and harsher areas like Chemical plants, Food and Dairy industry	Cable ties,bands & buckles,Marking systems.Best in Class for all Harsh environments like Marine & Offshore applications.



## Markets



Products sourced from Raychem RPG Limited deliver a distinct competitive advantage by meeting stringent requirements for cost, quality and performance. Make Raychem RPG your one-stop shop for all top quality products from India.

**Represented by:**



Contact us at:

**Raychem RPG Pvt. Ltd.** 

(A Tyco Electronics - RPG Enterprises JV)

### International Business Division

1/62, M. G. Road, Off. Western Express Highway, Sativali, Vasai (East), Thane - 401 208, INDIA

Tel : (+91)-(250)-3057 659/81/109, Direct (+91)-(250)-2481 845

Fax : (+91)-(250)-248 0046 / 248 0060, E-Fax : (+91)-(22)-5646 6957

E-mail : [pkamat@raychemrpg.com](mailto:pkamat@raychemrpg.com), [krishnanunni\\_g@raychemrpg.com](mailto:krishnanunni_g@raychemrpg.com), [molton\\_machado@raychemrpg.com](mailto:molton_machado@raychemrpg.com)

### Corporate & Head Office

RPG House, 463, Dr. Annie Besant Road, Worli, Mumbai - 400 030, India

Tel : (+91)-(22)-2493 7485 through 87

Fax : (+91) - (22)-2493 8879

Visit us: [www.raychemrpg.com](http://www.raychemrpg.com)